

PP60

PROGRAMMABLE PERISTALTIC PUMP
FOR CONTINUOUS DOSING





General safety information

This user manual contains basic information that should be observed during assembly, start-up, operation, and maintenance. Therefore, this user manual must be read by installers and operators prior to assembly and start-up, and must be accessible to every user of this unit. Additionally, all further safety information in this document absolutely must be observed. Read and follow all instructions. In order to minimize the danger of injury, do not allow children to use this product. Hazards from non-compliance with safety information. Non-compliance with safety information can result in hazards to persons, the environment, and the equipment. Non-compliance with safety information will result in a forfeit of any potential right to damage compensation.

Insufficient personnel qualification

Hazards in the event of insufficiently qualified personnel, potential consequence: Injury, heavy material damage.

- The system operator must ensure compliance with the required qualification level.
- Any and all work may only be performed by correspondingly qualified personnel.
- Access to the system must be prevented for insufficiently qualified persons, e.g. via access codes and passwords.

Potential overdosing of chemical agents

Despite ASIN Aqua® comprehensive safety functions, it is possible that a probe failure and other errors could lead to an overdosing of chemical agents. Potential consequence: Injury, heavy material damage.

- Design your installation such that uncontrolled dosage is not possible in the event of a probe failure or other errors, and/or such that uncontrolled dosage is recognized and halted before damage is incurred.
- Uncontrolled overdose of chemicals can cause harm to health and property. Even though the device contains a number of security elements can not be ruled out that in case of failure of the measuring probes, or the whole device may result in overdose of chemical agents. Install the equipment so that uncontrolled overdose of chemicals was not possible and that uncontrolled overdose has been detected in time before causing any harm. It is necessary to use chemicals in such quantities that an overdose will not cause dangerous concentration of chemical agents. Do not use chemicals in too large packages or with too high concentration.

Gaseous chlorine produced from dosing in standing water if dosing outputs are not closed via the filter pump

If the flow switch is stuck or experiences another error, there is a risk of dosing into standing water. Poisonous chlorine gas can be yielded when sodium hypochlorite and pH minus come together.

Non compliance with informational text

There is a great deal of informational text indicating hazards and their avoidance. Not observing informational text may lead to hazards. Potential consequence: gravest degree of injury, heavy material damage.

- Read all informational text carefully.
- Cancel the process if you are unable to exclude all potential hazards.

Use of new functions

Because of the continued development, a ASIN Aqua® unit may contain functions, which are not completely described in this version of the user manual. The use of such new or extended functions without a profound and secure understanding by the operator may result in malfunctions and severe problems. Potential consequence: Injury, heavy material damage.

- Make sure to get a profound and secure understanding of a function and relevant boundary conditions, before you start to use it.
- Check for an updated version of the user manual or additional documentation available for the relevant functions.
- Make use of the integrated help function of the ASIN Aqua® to get detailed information on functions and their parameter settings.
- In case it should not be possible to get a profound and secure understanding of a function based on the available documentation, do not use this function.

Overdosing if pH value is wrong

If disinfection is enabled before the pH value is stable in the ideal range of 7.0 to 7.4, then it may lead to heavy overdosing of chlorine or bromine. Potential consequence: Injury, heavy material damage.

- Do not start disinfection with chlorine until the pH value is stable in the ideal range between 7.0 and 7.4.

Conditions before using

Make sure you have a newest and updated version of the user manual and other documentation for all functions of the unit. Use and read the integrated help features. In case of not understanding the information about certain features of the unit, do not use these features.

Handling chemicals for pool water treatment

The chemicals used with the ASIN Aqua must be handled in a safe manner to prevent damage or personal harm. Aseko recommends you always use personal protective safety equipment when handling the pH and chlorine agents. Refer to the Materials Safety Data Sheet (MSDS).

WARNING: Never mix the pH agent with the chlorine agent. When carrying out maintenance on the clear plastic tubes or valves always rinse with clean water to prevent mixing of the pH and chlorine agents.



What's in the box

PP60 #13260



Peristaltic pump #12117

Injection valve
(PP60 PRG)
#12005



or
Injection valve SAUNA
(PP60 PRG SAUNA)
#12007



Suction tube weight
#12023



Dowels and screws



PE Tube 1/4" (6.35 mm)
transparent 10m
(PP60 PRG) #12008



or
PE Tube 1/4" (6,35mm) - black
(PP60 PRG SAUNA)
#12122



Optional accessories

Inserting DN50 plug 1/4" threaded
#12134



Fotometr
13076



ASEKO original chemicals

volume 20 l

CHLOR Pure 20l #12075



OXY PURE #13038



ALGICID #12156



volume 5 l

CHLOR Pure 5l #12138



OXY PURE #13039



ALGICID #12157



Peristaltic pump PP60

The peristaltic pump PP60 is suitable for dosing of aggressive chemicals e.g. acids, lyes and disinfection agents, especially for the treating of the pool water.

Technical description

Power supply	230 V / 50 Hz (or 12/24 V)
Power consumption	7 VA
Fuse	T32 mA
Over-voltage category	II
Ingress protection	IP30
Operating temperature	+5 to +40°C
Weight	526g
Installation	wall mounted
Pump output	60 ml/min max, back-pressure 1bar
Max. water pressure	1 bar
Dimensions	120 x 150 x 120 mm

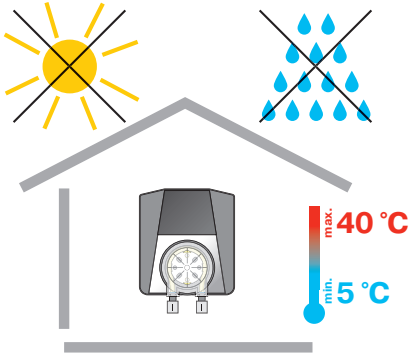

PP60 Installation

PP60 is to be wall mounted in dry and dust-free environment with temperature ranging from +5 °C to +40 °C. To mount the device, use the mounting holes that are accessible after opening the front cover of the device. To mount the device use screws supplied with the device.

WARNING: The location temperature should permanently be in the range from +5 °C to +40 °C.

Direct sunlight, high humidity and dust may lead to damage to PP60.

- Before installing, ensure that pool water is chemically clean and free of dirt.
- The maximum distance of injection valves from peristaltic pump of PP60 must not be greater than 8 m.
- Vertical distance between PP60 and the bottom of containers must not exceed 2 m.

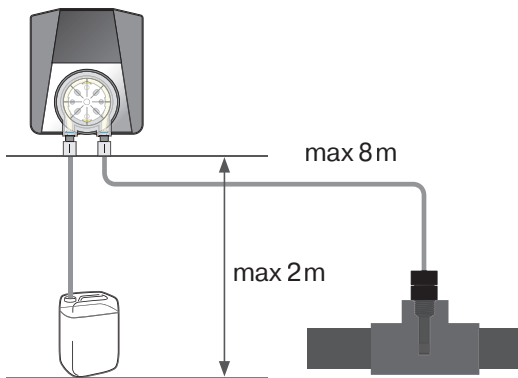
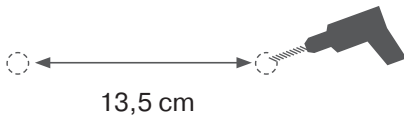
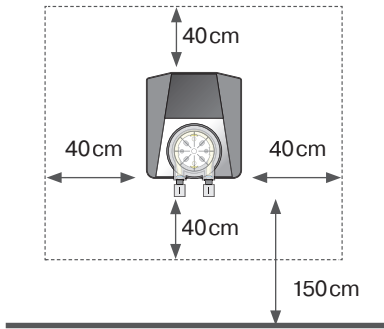

Pool Chemicals Connection

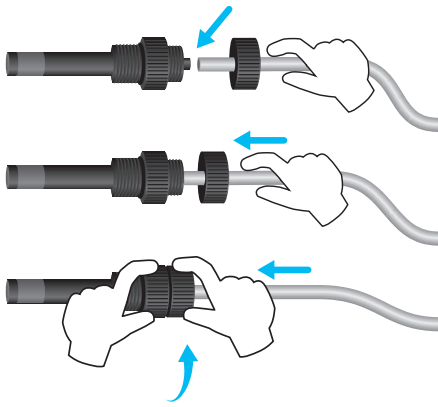

At this step is necessary to connect the injecting valves of individual chemicals to the dosing pumps and dosed agents.

Place the injecting valve in the T-joint, blinded with the DN50 G1/4" threaded plug #12134.

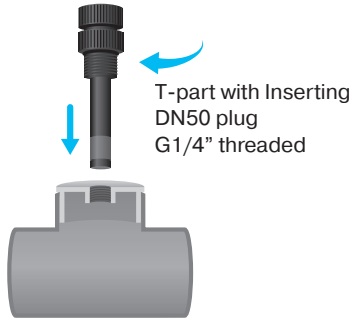

1. Cut the PE tube at 90 ° angle to ensure proper fitting.

- Use the sharp knife to cut plastic. The cut must be clean and smooth.

2. Drill the 6 mm hole and the 1 mm hole (air suction) into the CHLORPURE canister cap. Push the PE tube through the cap. Select the tube distance so that the tube reaches the canister bottom and can be connected to the pump as straight as possible. A long tube in the canister would bend and produce air bubbles.

3. Put a weight on the tube end and dive it in the canister.

4. Connect the plastic tube from the pH canister to the pump to the left connection.

5. Connect the plastic tube to the pump right connection and the injection valve.

6. Hand screw the injection valve in the specified mounting hole (see diagram).

- The injection valve is installed in G 1/4" thread.

- Check throughput of the injection valves and tightness of the entire system.

WARNING: Only hand tighten. Do not use tongs or any other tools.

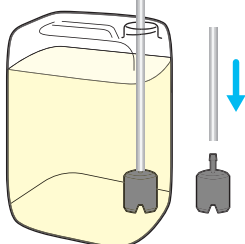
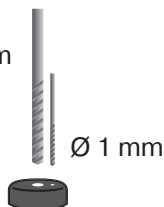
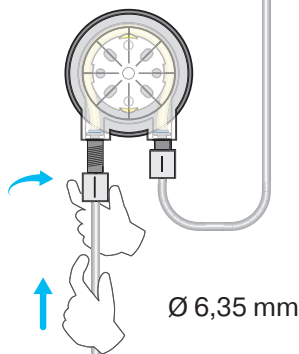
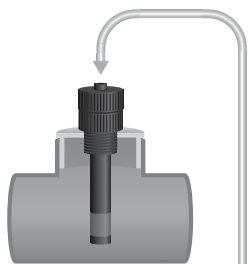

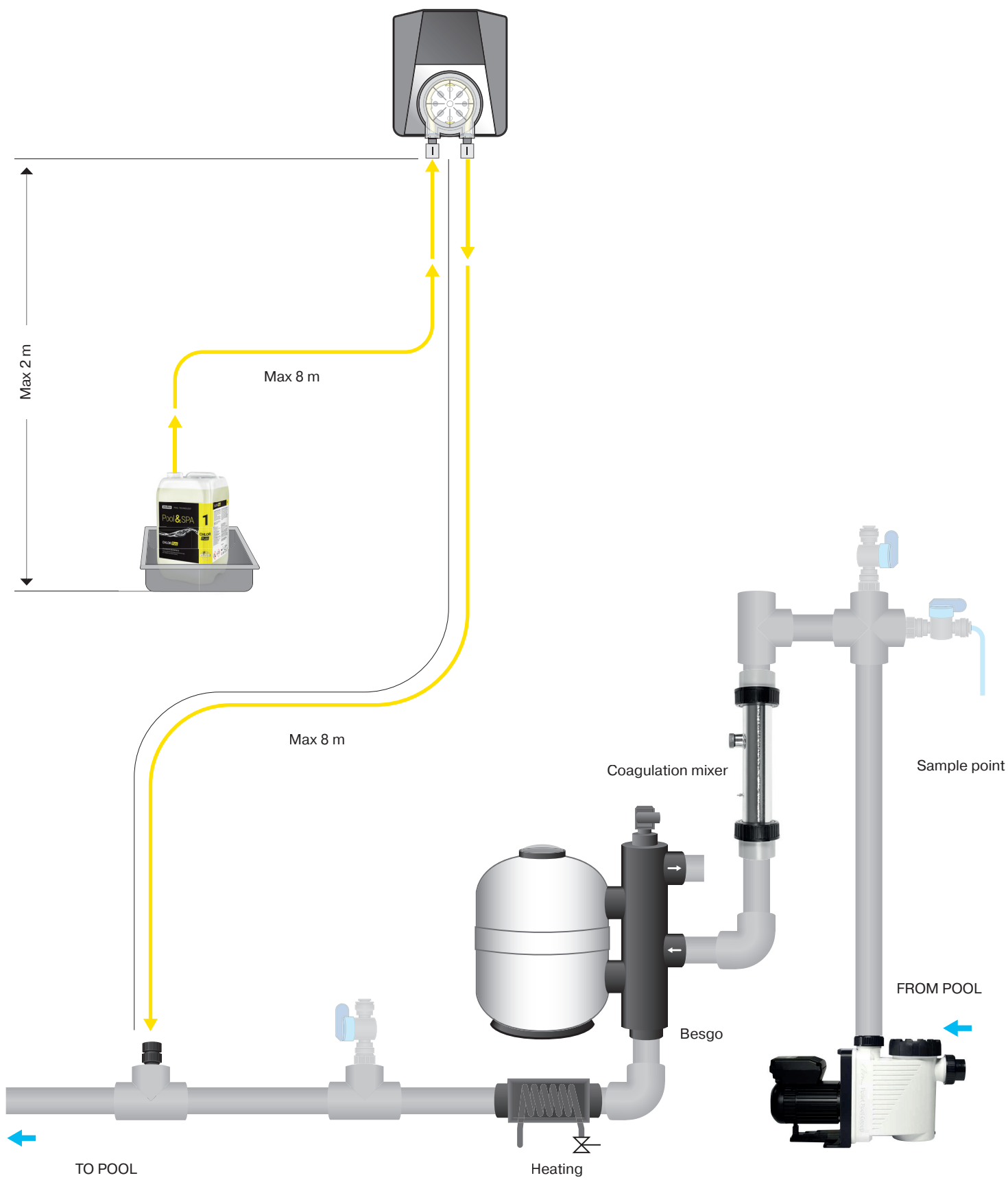

Initial start

The PP60 PRG is started by plugging the cable into the socket. The power supply must be shared with the power supply to the circulation pump. Switching off the circulation pump must switch off the PP60 PRG, otherwise incorrect dosing into standing water would occur. We recommend to run PP60 PRG in clean water without any pool products.

It is also advisable to test the connections of the connecting pipes. After starting the device, dosing starts. Visually inspect the dosing fluid for leaks at any joint. After switching off the device, check that the liquid in the hose does not fall back.

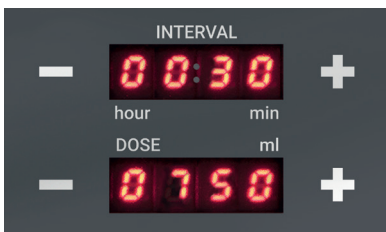

Initial setup

1. When the power supply cable is plugged in, the two LED displays will light up.
2. Press any + or - button to switch the device to setting mode. In setting mode, both displays flash.
3. In the upper display, use the upper + and - buttons to set the dosing interval. Press once to change the displayed value by one unit, hold to change the displayed value faster.
4. On the lower display, use the lower + and - buttons to set the dose in ml which will be dosed in each interval. One press changes the value by one unit, holding it changes the displayed value faster.
5. After the setting is completed, both displays flash for approx. 10 seconds and then the pump automatically starts the dosing.

The maximum time that the pump doses is 5 minutes. Then the pump stops dosing for 5 minutes and then starts the dosing again. This procedure is repeated until the required amount is dosed. For example see chart below.

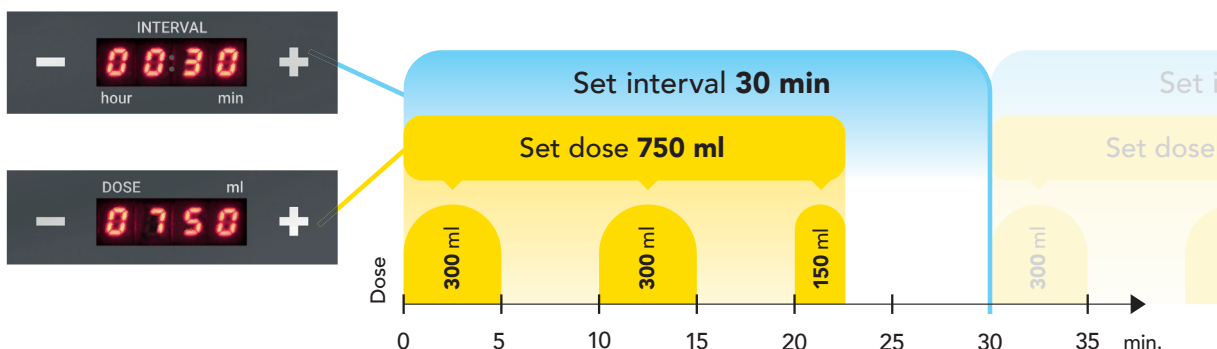

Error messages

Agent Run Out

- Check liquid levels on a regular basis, refill in time.

Dosing Pump does not Dose

- Leakage in connection of PE tubes or they are damaged.
- Failure of dosing pump. Check whether pump is running. If so, check the hose inside the pump for damage or breakage and replace it, if required.

Injection Valve Clogged

- Impassable injection valve.
Check the valve for being clogged with impurities or deposits or the rubber seal for being damaged.
- Failure of dosing pump. Check whether pump is running.
If so, check the hose inside the pump for damage or breakage and replace it, if required.

Fuse failed

If the input voltage to the peristaltic pump is OK and the pump does not work, the mains fuse may have failed. The fuse is located on the PCB inside of the device. To replace the fuse follow the procedure below:

1. unplug the power cord
2. unscrew and remove the front cover of the pump
3. replace fuse
4. restore the device to its original state

PP60 maintenance

To ensure the optimum efficiency, perform visual checks and maintenance of PP60 on a regular basis.

#12073 Replacement tube kit for PP 60

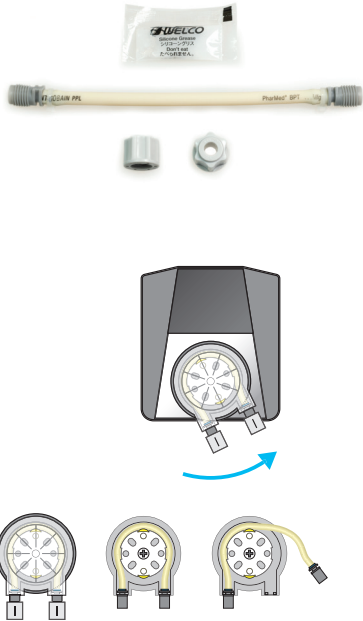

Pump Hose Replacement

To prevent the pump from failing, it is recommended to replace the hose #12073 every 24 months.

In doing so, proceed as follows:

- Switch off PP60.
- Turn the pump cover cassette counterclockwise and take it out of PP60.
- Release both hose ends and take it out of the cassette.
- Lubricate the new hose with the supplied special grease.
- Insert the lubricated hose into the cassette.
- Place the cover cassette back on PP60 and turn it clockwise to lock it.
- Use new nuts, which are part of the replacement hose set, for connection of the PE tube.

#12005 Injection valve



#13087 Injection valve rubber



Injection Valve Maintenance

On a regular basis, check throughput of the injection valves, rubber band integrity, remove scale.

In case of private pools, replace injection valve rubber bands every 2 years.
In case of public pools, replace injection valve rubber bands every year.



USER MANUAL

PP60

