

Installation and user manual - English
Battery-powered electric cleaner
Translation of the original instructions in French

EN

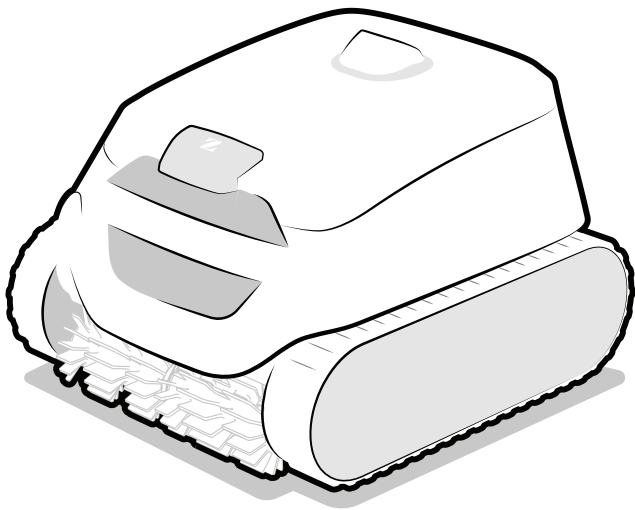

More documents on:
www.zodiac.com



CE EAC UK CA 
according to product marking

H0753400.C - 2023/10 - **EB3102**

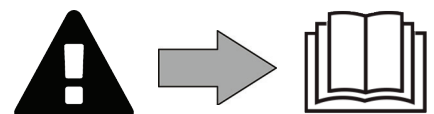



WARNINGS

- Before handling the appliance, it is vital that you read this installation and user manual, as well as the "Warranties" booklet delivered with the appliance. Failure to do so may result in material damage or serious or fatal injury and will void the warranty.
- Keep and pass on these documents for reference during the appliance's service life.
- The distribution or modification of this document in any way is prohibited, without prior authorisation from Zodiac®.
- Zodiac® is constantly developing its products to improve their quality. The information contained herein may therefore be modified without notice.

EN

GENERAL WARNINGS

- Failure to respect the warnings may cause serious damage to the pool equipment or cause serious injury, even death.
- Only a person qualified in the technical fields concerned (electricity, hydraulics or refrigeration) is authorised to carry out maintenance or repair work on the appliance. The qualified technician working on the appliance must use/wear personal protective equipment (such as safety goggles and protective gloves, etc.) in order to reduce the risk of injury occurring when working on the appliance.  
- Before handling the appliance, check that it is switched off and isolated.
- The appliance is intended to be used for pools and spas for a specific purpose; it must not be used for any purpose other than that for which it was designed.
- This appliance is not intended for use by individuals (including children) with impaired physical, sensorial or mental abilities, or persons lacking in knowledge and experience, unless they receive supervision or prior instructions on using the appliance from a person responsible for their safety. Children must be supervised to ensure that they do not play with the appliance.
- This appliance can be used by children under 8 and adults with impaired physical, sensory or mental capabilities, or who lack experience and knowledge, if they are correctly supervised or have been instructed in how to use the appliance safely and understand the hazards involved. Children and pets shall not play with the appliance. This is not a toy. User cleaning and maintenance operations must not be carried out by children without supervision.
- The charging of the appliance must follow standard IEC / HD 60364-7-702 and required national rules for swimming pools, should you have any doubts please consult your dealer.
- The appliance must be installed according to the manufacturer's instructions and in compliance with local and national standards. The installer is responsible for installing the appliance and for compliance with national installation regulations. Under no circumstances may the manufacturer be held liable in the event of failure to comply with applicable local installation standards.
- For any work other than the simple user maintenance described in this manual, the product should be referred to a qualified professional.
- If the appliance suffers a malfunction, do not try to repair it yourself; instead contact a qualified technician. The product manufacturer is exempt from all liability regarding any damage caused by unauthorized spare parts or accessories.
- Refer to the warranty conditions for details of the permitted water balance values for operating the appliance.
- Deactivating, eliminating or by-passing any of the safety mechanisms integrated into the appliance shall automatically void the warranty, in addition to the use of spare parts manufactured by unauthorised third-party manufacturers.
- Do not spray insecticide or any other chemical (flammable or non-flammable) in the direction of the appliance, as this may damage the body and cause a fire.
- Do not touch the fan or moving parts and do not place objects or your fingers in the vicinity of the moving parts when the appliance is in operation. Moving parts can cause serious injury or even death.
- Do not operate the cleaner or leave outside during freezing weather condition.

WARNINGS ASSOCIATED WITH ELECTRICAL APPLIANCES

- The power supply to the appliance charging station must be protected by a dedicated 30 mA Residual Current Device (RCD), complying with the standards and regulations in force in the country in which it is installed. Contact a qualified electrician if you cannot verify that the circuit is protected by a RCD.
- Do not use any extension lead when connecting the charging station; connect the station directly to a suitable power supply.
- Before carrying out any operations, check that:
 - The required input voltage indicated on the charging station information plate corresponds to the mains voltage;
 - The mains supply is compatible with the appliance's electricity needs and is correctly grounded.
- In the event of abnormal operation or the release of odours from the appliance, turn it off immediately, unplug the appliance from the charging station where necessary and contact a professional.
- Before servicing or performing maintenance on the appliance, check that it is powered off and completely disconnected from the charging station and that all other equipment or accessories connected to the appliance are also disconnected from the power circuit.
- If the power cord is damaged, it must be replaced by the manufacturer, an authorised representative or a repair facility only.
- Before connecting the appliance to the charging station, check that the connection unit or socket to which the appliance will be connected is in good condition and shows no signs of damage or rust.
- In stormy weather, disconnect the appliance from the power supply to prevent it from suffering lightning damage.
- The product contains magnets and components that emit electromagnetic fields. The magnets and electromagnetic fields can interfere with pacemakers, defibrillators and other medical devices. Keep a safe distance between the medical device and the product. Consult your doctor or the manufacturer of the medical device for specific information about it. If you think that the product is interfering with a pacemaker, defibrillator, or any other medical device, stop using the product starting from the distance at which you feel interference.

WARNINGS ASSOCIATED WITH BATTERY-POWERED ELECTRICAL APPLIANCES

- Do not use a battery block, cleaner or charging station that is damaged or modified. Damaged or modified batteries may exhibit unpredictable behavior resulting in fire, explosion or risk of injury.
- Do not handle the cleaner and the charging station while it is charging with wet limbs and without shoes.
- Do not attempt to clean the impeller when the cleaner is in water or on a wet surface. This may lead to severe injury.
- Recharge only with the charging station specified by the manufacturer. A charging station that is suitable for one type of battery pack may create a risk of fire when used with another battery pack.
- Do not expose charging station or cleaner to fire or excessive temperature. Exposure to fire or temperature above 65°C may cause explosion.
- The appliance must be charged in a temperature between 5-35°C.
- Follow all charging instructions and do not charge the battery operated appliance outside of the temperature range specified in the instructions. Charging improperly or at temperatures outside of the specified range may damage the battery and increase the risk of fire.
- The charging station can be used indoor in a dry and well ventilated area or outdoor in dry area, away from direct sunlight, children, heat, ignition sources, and pool chemicals.
- Never attempt to open the charging station.
- Do not touch the charge plates on the charging station or on the cleaner after charging because of the temperature of these components during charging.
- The battery installed is a rechargeable Li-ion battery pack. Never attempt to disassemble or replace it. A battery can produce a short circuit causing severe burns.

Avoid contact between any wires or metal items that could cause sparking and short circuit the battery. If a battery leak occurs, avoid any contact with the leaking fluids and contact a professional to replace the battery. Wear complete eye protection, gloves and protective clothing when disposing of cleaner. If leaking fluids come in contact with skin and clothing, wash immediately with plenty of soap and water. If leaking fluids come in contact with eyes, do not rub eyes, immediately flush eyes with cool running water for at least 15 minutes and do not rub them. Seek medical attention as soon as possible.

- Battery and cleaner must be disposed of in accordance with local requirements. Always dispose of batteries in a sustainable way in approved collection bins or at authorised collection centers in accordance with local law. Contact your local authority for more information.

EN

SPECIFIC FEATURES APPLICABLE TO "Pool cleaners"

- The cleaner is designed to operate properly in pool water at a temperature of between 10°C and 35°C.
- To avoid possible injury or damage to the cleaner, do not operate the cleaner out of the water.
- In order to prevent possible injury, bathing is prohibited when the cleaner is in the pool.
- Do not use the cleaner during shock chlorination.
- Do not leave the cleaner unattended for an extended period.
- If you are planning on using the robot in a saltwater pool, make sure all salts are dissolved before placing it into the water.

WARNING ON THE USE OF A CLEANER IN A POOL WITH A LINER

- Before installing the cleaner, carefully inspect the pool lining. If the liner comes away or is damaged in places, or if stones, folds, roots or corrosion appear, do not install the cleaner before a qualified professional repairs or replaces the liner. The manufacturer may not be held liable in any way for damage caused to the liner.
- The surface of certain patterned liners can wear away quickly: the patterns and/or colours can become deteriorated, faded or disappear on contact with certain objects (cleaning brushes, toys, rubber rings and floats, chlorine dispensers, or cleaners). The cleaner manufacturer may not be held liable for wear to the liners or faded patterns, which are not covered by the limited warranty.

WARNING ON THE USE OF A CLEANER IN A STAINLESS STEEL POOL



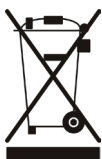

- The surface of some stainless steel pools may actually be very fragile. The surface of these pools can become damaged by the natural rubbing of debris against the coating, caused for example by cleaner wheels, tracks or brushes, including those of electric pool cleaners. The cleaner manufacturer may not be held liable for wear or scratching affecting stainless steel pools, which are not covered by the limited warranty.



Recycling

This symbol is required by the European directive DEEE 2012/19/EU (directive on waste electrical and electronic equipment) and means that your appliance must not be thrown into a normal bin. It will be selectively collected for the purpose of reuse, recycling or transformation. If it contains any substances that may be harmful to the environment, these will be eliminated or neutralised. Contact your retailer for recycling information.

CONTENTS

	1 Information before using the appliance	5
1.1	Description	5
1.2	Technical specifications and parts list	6
1.3	Operating principle	7
1.4	Pool preparation	7
	2 General use	8
2.1	Assembling the charging station	8
2.2	Installing the station and charging the cleaner	9
2.3	Description of the interface	10
2.4	Description of the indicators	11
2.5	Starting a cleaning cycle	12
2.6	Removing the cleaner from the water	14
2.7	Storing the cleaner	15
	3 Using the iAquaLink™ app	16
3.1	First-time cleaner configuration	16
3.2	Functions available in the iAqualink™ app	17
	4 Maintenance	18
4.1	Cleaning the cleaner and charging station	18
4.2	Cleaning the filter	18
4.3	Cleaning the brushes and the centre bridge	19
4.4	Cleaning the cover seal	19
4.5	Cleaning the propeller	20
4.6	Replacing the brushes	21
4.7	Replacing the battery block	22
4.8	Winterising	22
	5 Troubleshooting	23
5.1	Appliance behaviour	23
5.2	Charging station behaviour	24
5.3	User alerts	25
5.4	Troubleshooting the connection to the iAquaLink™ app	27



Tip: to make it easier to contact the retailer

Write down the retailer's contact details to help you find them more easily and fill in the "product" information on the back of the manual: the retailer will ask for this information.



1 Information before using the appliance

1.1 I Description

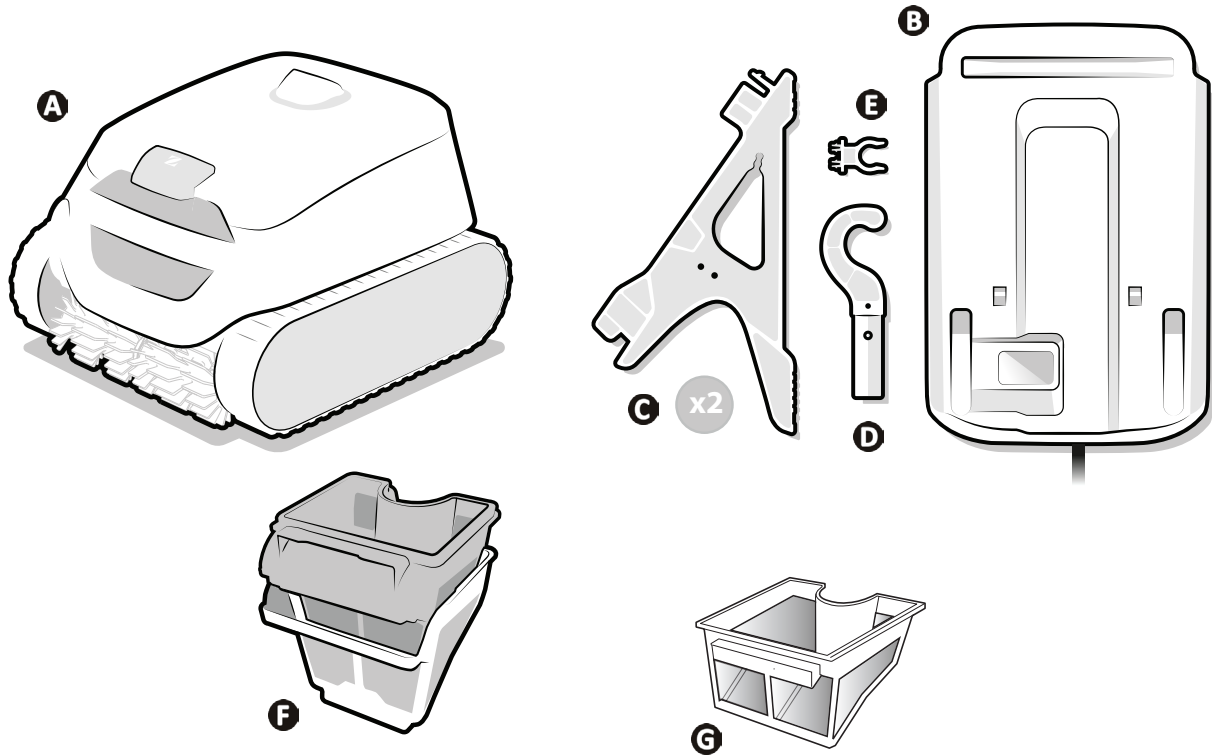

EN

		RF 5200 iQ CNX-Li 52XX iQ 52 XA-Li iQ XA-Li 52XX iQ	RF 5400 iQ
A	Cleaner	✓	✓
B	Charging station (to assemble)	✓	✓
C	Foot (x2)	✓	✓
D	Hook*	✓	✓
E	Hook holder	✓	✓
F	Dual filtration (150/60 μ)	✓	
G	Single filtration (100 μ)	+	✓

* To mount on a pool pole (standard, not supplied): Required to remove the cleaner from the water.

✓: Included

+: Available as an option

1.2 I Technical specifications and parts list

1.2.1 Technical specifications

Charging station power supply voltage	110 - 240 VAC, 50/60Hz, Classe II*	
Cleaner power supply voltage	25.4 VDC	
Charge voltage	29.4 VDC	
Charger maximum power	58 W / 29,4W**	
Battery capacity	10 Ah / 6.4Ah**	
Cleaner rated power	130 W	
Filter capacity	4 L	
Cleaner size (L x W x h)	41 x 42 x 28 cm	
Package size (L x W x H)	56 x 56 x 38 cm	
Cleaner weight	9.2 kg	
Packaged weight	15.5 kg	
Suction width	230 mm	
Maximum operating depth	4 m	
Protection rating	Charging station	IPX5
	Cleaner	IPX8
Frequency bands	2.412GHz - 2.484GHz	
Radio output power	20.5 dBm	

* Class II: appliance with double insulation or reinforced insulation that does not require grounding.

** Depending on the model.

1.2.2 Parts list

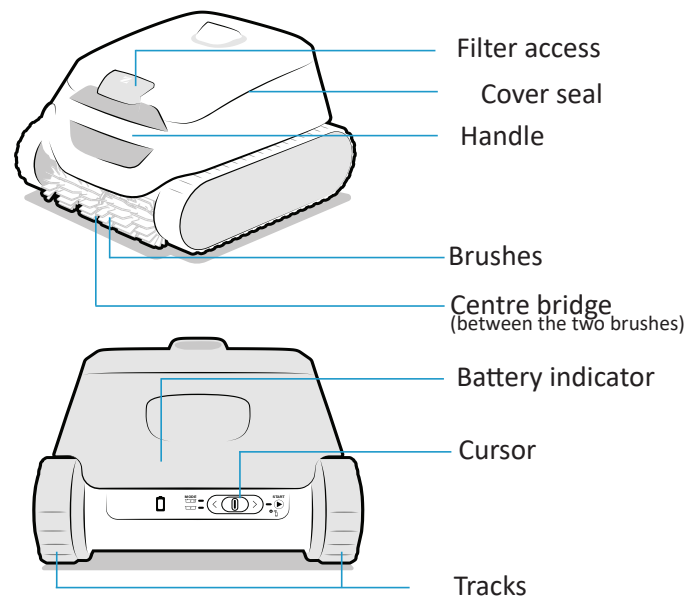

1.3 I Operating principle

The cleaner is independent of the filtration system and can, once charged, operate autonomously. It finds the best route to move around and clean the areas of the pool for which it has been designed (floor, walls, waterline or floor only). Debris is sucked in and stored in the cleaner's filter.

The cleaner can be used:

- By selecting an operating mode and starting a cycle with the cursor on the rear of the cleaner, or
- Via a smartphone or a tablet compatible with the iAquaLink™ app (see "3 Using the iAquaLink™ app").

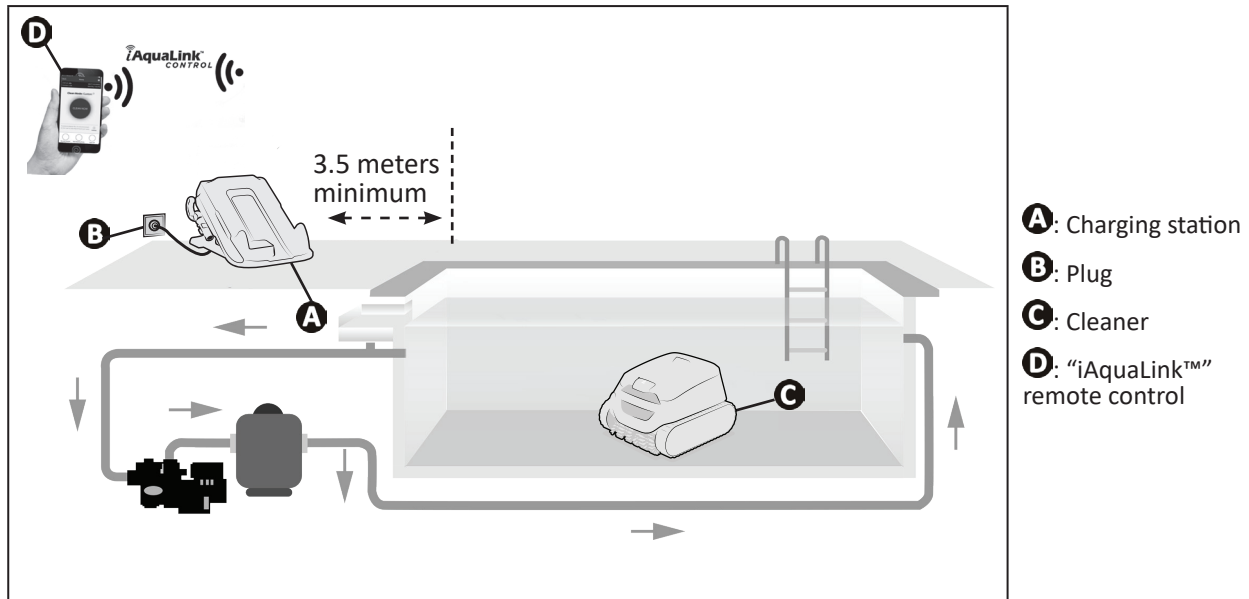

EN

1.4 I Pool preparation

 This product is intended to be used in pools which are permanently installed. Do not use it in pools which may be dismantled. A permanent pool is built into the ground or on the ground and cannot be easily dismantled and stored.

- The appliance must operate in pool water with the following properties:

Water temperature	Between 10°C and 35°C
pH	Between 6.8 and 7.6
Free chlorine	< 3 mg/l

- When the pool is especially dirty, especially when commissioning, remove the largest debris using a net in order to optimise the appliance's performances.
- Remove any thermometers, toys and other objects that might damage the appliance.



2 General use

2.1 | Assembling the charging station

Assemble the charging station before use:

- Slide the top of the foot (marked with a blue dot) into the slot at the front of the charging station (also marked with a blue dot) (1).
- Push the foot fully home under the station (the bottom of the foot (2) should clip in).
- Attach the hook on the side of the charging station (on the right or the left to match the desired location) (3).
- Roll out the cable to run it to the rear of the station or on one side, depending on the desired installation (a slot to hold the cable is provided inside each foot).

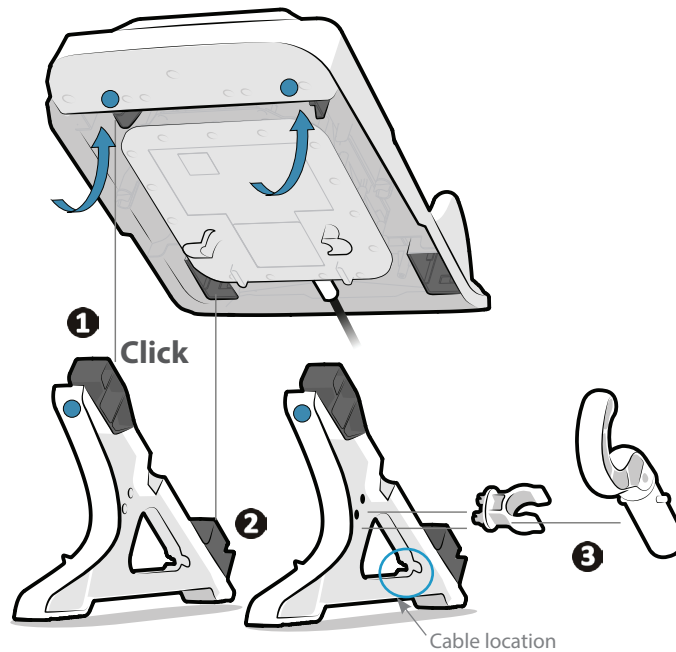



2.2 I Installing the station and charging the cleaner

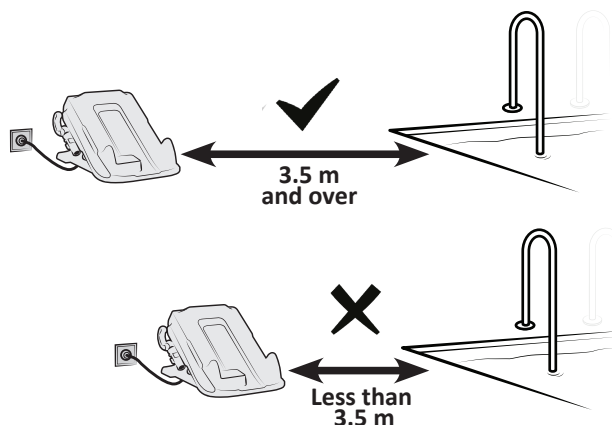

- The station must not be immersed in water or any other liquid. It must not be installed in a floodable area.
- **DO NOT** place charging station in direct sunlight.

- Place the charging station:
 - Close to an easily accessible power outlet (located out of the rain and from splashing),
 - in the shade. **DO NOT expose cleaner and base to direct sunlight when charging cleaner.**
 - more than 3.5 metres from the edge of the pool.



- Connect the charging station.
- Position the cleaner on the charging station so that the rear of the cleaner (the cursor end) come into contact with the slots provided on the rear of the station. When the cleaner is correctly positioned, an **audible signal** is heard and the indicator  blinks slowly (orange).



- Temperature range for charging : 5 - 35°C.
- Make sure that the charge plates on the charging station and on the cleaner are clean and dry before charging.
- Do not touch the charge plates on the charging station or on the cleaner right after recharging the cleaner.

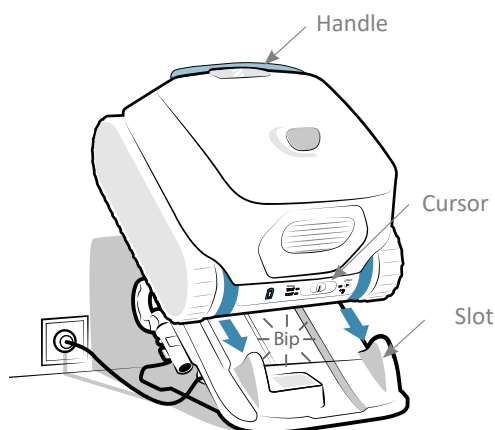

- Before using the cleaner for the first time, charge it fully: The indicator  changes to steady (green) once it is fully charged. **Charging stops automatically as soon as the cleaner is fully charged. Therefore there is no need to disconnect the station or to remove the cleaner.**







- When all of the indicators are off, the cleaner is on standby. Slide the cursor to the left or to the right to wake up the cleaner. If this does not work, place the cleaner back on the charging station (the cleaner goes into deep sleep after 8 days of inactivity).
- If the indicator  does not blink when the cleaner is first placed on charge, see "5.1 I Appliance behaviour".
- To get the advantages of connectivity (software updates, battery status, information on the cycle, see "3.2 I Functions available in the iAqualink™ app"), place the charging station in a location where Wi-Fi is accessible.

2.3 I Description of the interface

Thanks to the interface on the rear of the cleaner, you can choose the cleaning mode and start a cleaning cycle and also get information on cleaner, battery or connectivity status.

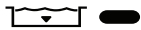
Additional functions and information can also be accessed from the app, see "3 Using the iAqualink™ app".

Function	
Keys	
	Cursor (choice of mode, start a cycle, see "2.5 I Starting a cleaning cycle")
Indicator lights	
	Battery status
	"Floor + walls + waterline" mode activated
	"Floor" mode activated
	Cleaner status
	Wi-Fi connection status





- When all of the indicators are off, the cleaner is on standby. Slide the cursor to the left or to the right to wake up the cleaner. If this does not work, place the cleaner back on the charging station (the cleaner goes into deep sleep after 8 days of inactivity).

2.4 I Description of the indicators

2.4.1 Cleaner status indicator





 → Blinking indicator  → Indicator on

 Blue	Ready for immersion
 Blue	Cycle in progress
 Red	Cleaner error, see "5.3.1 Cleaner error"

EN



2.4.2 Charge indicator

 → Blinking indicator  → Indicator on

 Green	Charged: ready for use, fully charge
 Green	Charging (<5h): ready to run a complete cycle
 Orange	Partially charged: can be used (cycle will be shorter)
 Orange	<ul style="list-style-type: none"> • If the cleaner is on the station: Charging • If the cleaner is not on the station: Needs to be recharged and cannot be used
 Red	Battery error, see "5.3.2 Battery error"

2.4.3 Connectivity indicator

 → Blinking indicator  → Indicator on



Off	Not connected to Wi-Fi
 Blue	Connecting
 Blue	Connected to Wi-Fi

2.4.4 Charging station status indicator

An indicator under the charging station shows its status.

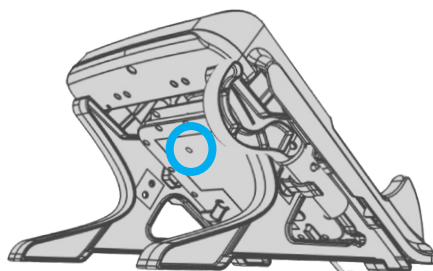
 → Indicator on



 Green	<ul style="list-style-type: none"> • Station powered, not charging • If the indicator is green and the cleaner is on the station, see "5.2 I Charging station behaviour".
 Red	Cleaner charging



- If the indicator is off or blinking when the station is plugged in, see "5.2 I Charging station behaviour".

2.5 | Starting a cleaning cycle



- In order to avoid any risk of injury or material damage, follow the instructions below:**
- Bathing is prohibited when the appliance is in the pool.
 - Do not use the appliance during a shock chlorination. Wait until the chlorine level has reached the recommended value before immersing the cleaner.
 - If the pool is covered, use the "Floor only" cleaning mode.

To start the cleaning cycle:



- Wait until the cleaner is charged ( steady or flashing green) to start a cycle.
- Once charged, remove it from its charger station and take it to the pool.
- Choose the cleaning mode, see "2.5.1 Choice of cleaning mode".
- Start the cycle, see "2.5.2 Starting the cleaning cycle".
- Immerse the cleaner, see "2.5.3 Immersing the cleaner".

2.5.1 Choice of cleaning mode

The cleaning mode defines the surface to be cleaned and the duration of the cleaning cycle.

- Slide the cursor on the rear of the cleaner to the left:
 - One notch to select the "Floor only" mode,
 - A second notch to select the "Floor + walls + waterline" mode.

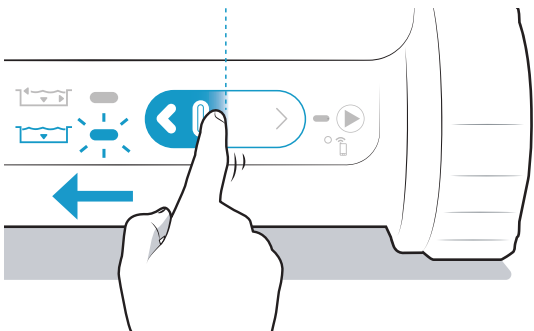
The indicator corresponding to the mode will light.

	Surface to clean	Cycle duration
	 <p>Floor only</p>	1h30
	 <p>Floor + walls + waterline</p>	2h / 2h30*

* Depending on the model



- Additional modes are available via the application (Waterline mode, Smart mode), see "3.2 | Functions available in the iAqualink™ app" (depending on the model).

2.5.2 Starting the cleaning cycle

- Slide the cursor on the rear of the cleaner to the right to start the cycle.
- The indicator  blinks while waiting for the cleaner to be immersed.

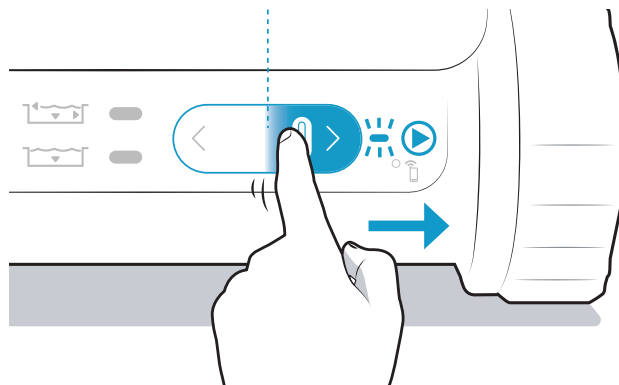

EN

Tip: To improve cleaning performance



- At the start of the bathing season, run several cleaning cycles in floor only mode (after removing the large debris with a net). Regular use of the cleaner (without exceeding 3 cycles per week) means that your pool will always be clean and the filter less clogged. We recommend running a few cycles without the debris filter to perform a rough clean, see "4.2 | Cleaning the filter" to disassemble the filters.

2.5.3 Immersing the cleaner

- Place the cleaner vertically into the water and hold it there while moving it slightly in all directions so that the air contained in it escapes.
- Let the cleaner sink to the bottom of the pool. The cycle will start at the latest 40 seconds after the cleaner detects that it is in water. The cleaner adapts its movement strategy to the cleaning mode, in order to optimise its level of coverage.

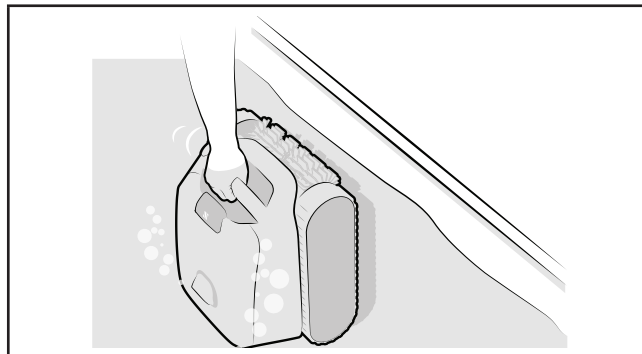

2.6 I Removing the cleaner from the water



- Using the pole, you can remove the cleaner during the cycle and the cleaner will stop automatically once it is out of the water.
- At the end of a cycle, the cleaner always stops at the foot of a side.

2.6.1 Without the iAquaLink™ app

During the last ten minutes of the cycle, the cleaner will successively climb the various sides and wait at the waterline until it is recovered using the handle (not available in the "Floor only" mode).

- 1** If it is not retrieved at this time, the cleaner at the foot of a side at the end of the cycle

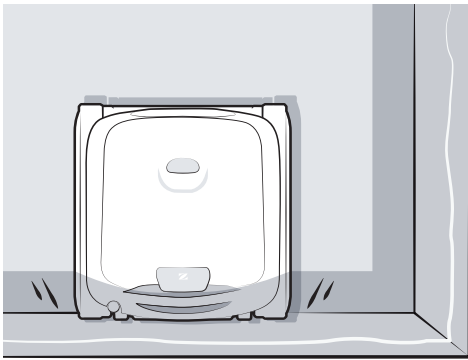

- 2** Attach the hook (supplied) to the end of a pool pole (not supplied)

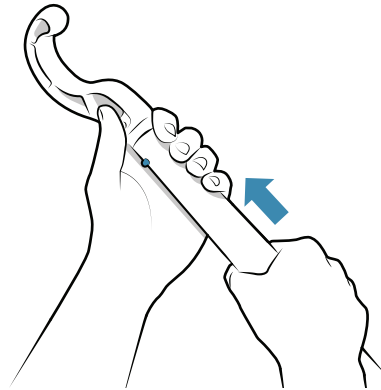

- 3** Catch the cleaner handle with the hook and raise the cleaner to the surface

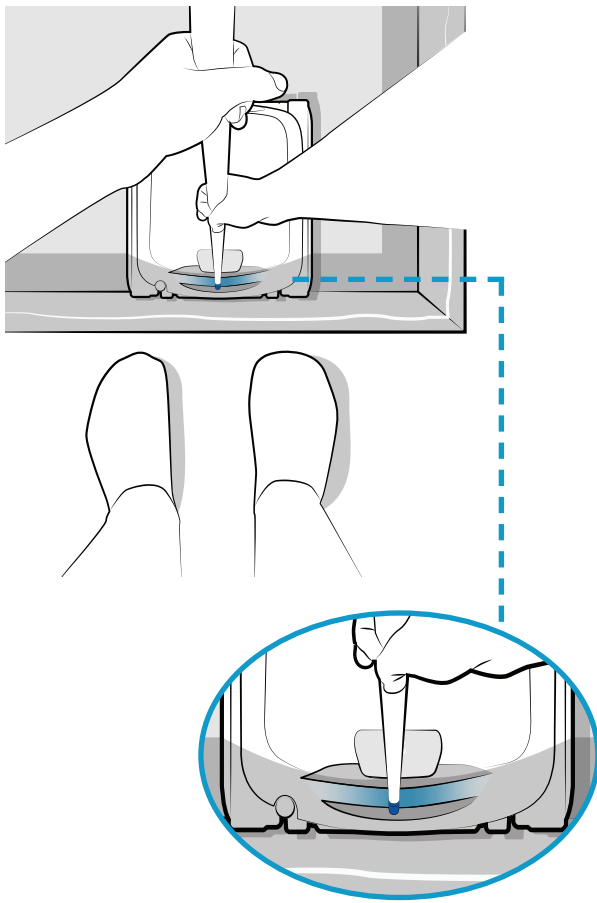

- 4** Use the handle to take it out of the water. The cleaner expels water through a rear jet to make it lighter

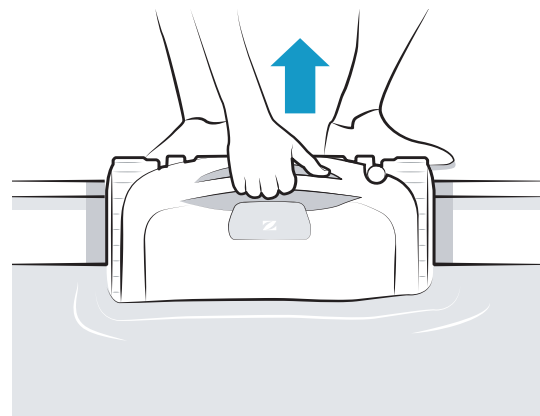

2.6.2 With the iAqualink™ app

1 When Push notifications have been allowed (iAqualink™ app phone's settings), the cleaner warns you that the cycle is coming to an end. From this time on and during the last ten minutes of the cycle, the cleaner will successively climb the various sides and wait at the waterline until it is recovered using the handle (not available in the "Floor only" mode).

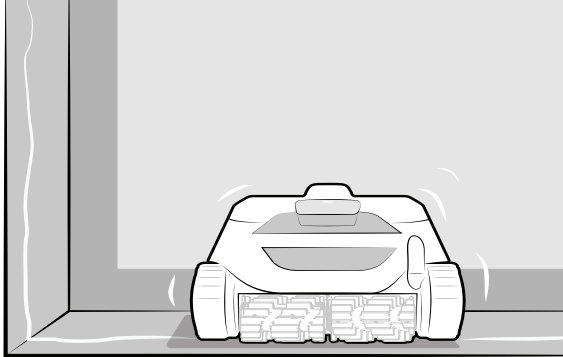

2 Use the handle to take it out of the water. The cleaner expels water through a rear jet to make it lighter.

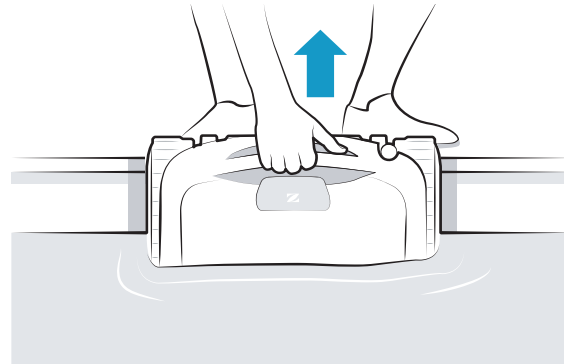

EN

2.7 | Storing the cleaner



- DO NOT leave the cleaner uncharged: always recharge the cleaner after use.
- Make sure that the cleaner and the charge plates are clean and dry before charging.
- DO NOT leave the cleaner to dry out in sunlight after use.
- DO NOT leave cleaner in water when not in use.
- DO NOT expose cleaner to fire, excessive temperatures, ignition sources, or pool and spa chemicals.
- Store all the elements away from sunlight, humidity and bad weather.
- Store out of reach of children and pets.

- Place the dry cleaner on the charging station.
- Store all elements away from direct sunlight and any splashes.

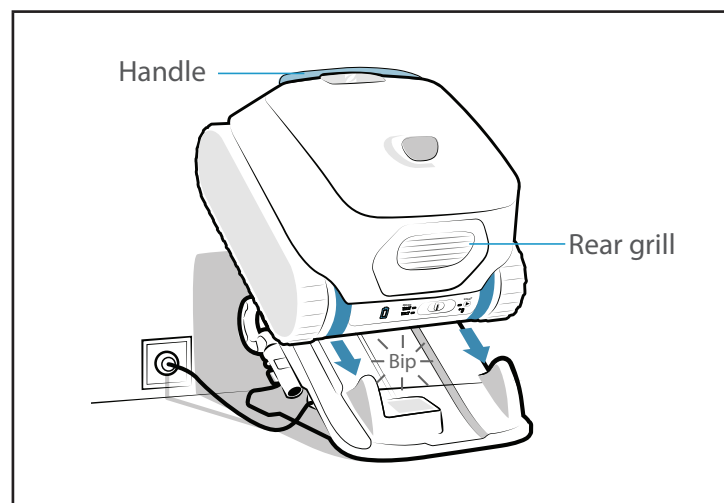



3 Using the iAquaLink™ app

Mobile device
(smartphone or tablet)

Home Wi-Fi
network

Cleaner

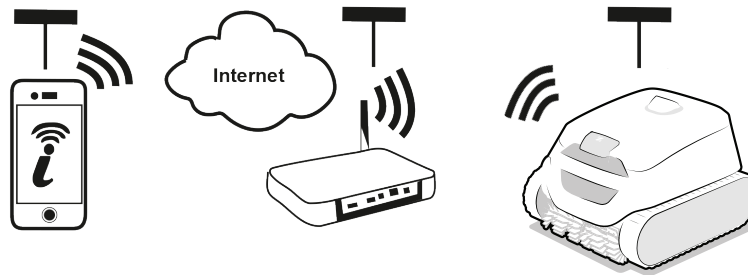

The iAquaLink™ app is available for iOS and Android systems.

3.1 I First-time cleaner configuration

Before you install the app, you must:

- First charge the cleaner,
- Use a Wi-Fi-enabled smartphone or tablet,
- Use a Wi-Fi network with a signal that is powerful enough to connect to the cleaner: It must be possible to detect the Wi-Fi signal where the cleaner is used. If this is not the case, a technical solution must be provided to amplify the existing signal.
- Have your home Wi-Fi network password at the ready.

- Download the iAquaLink™ app from the App Store (iOS) or Google Play Store (Android).

1 Log in or register.



2 Press the + icon to add a new appliance and follow the instructions in the app.



3 Follow the steps displayed in the app. When required, slide the cursor to the right and maintain it for 10 seconds, until the  indicator blinks to activate the Bluetooth™.

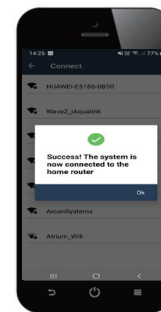
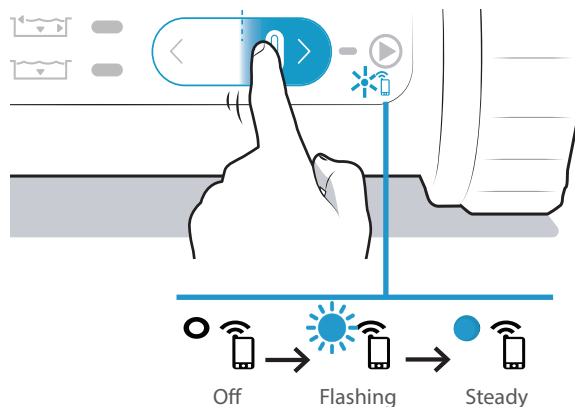

- A message is displayed on-screen to show that the Wi-Fi connection has been correctly established between the cleaner and the home router. (*)
- The  indicator on the rear of the cleaner comes on.



(*): If an error message appears or if the connection still isn't made, refer to the table "5.3 I Troubleshooting the connection to the iAquaLink™ app".

3.2 I Functions available in the iAqualink™ app



- When the cleaner is in the water, iAqualink™ app functions are no longer available.

When the cleaner is out of the water, the app allows:

- **Choosing a mode and starting a cycle.** Starting a cleaning cycle from the app opens a pop-up. **Close the pop-up to allow the cleaner to start.**
- Accessing two modes exclusively available in the app: The "**Waterline**" mode and the "**Smart**" mode (automatic time adjustment) (depending on the model),
- Accessing the **troubleshooting assistance functions** via errors returned : press the warning symbol  to display the troubleshooting solutions, see "5.3 I User alerts".
- **Easier removal from the pool:** When Push notifications have been allowed (iAqualink™ app phone's settings), the app informs you when the cleaner is waiting to be removed at the waterline of the pool (during the last minutes of the cycle) (not available in the "Floor only" mode).
- Informing you of the cleaner **charge level**.



Charged: ready for use



Charging: ready for use



Charging



Partially charged

When the cleaner is out of the water, press the  icon to access certain information on the cleaner at any time (serial number, etc.) via the Settings Menu and access.

EN



4 Maintenance



- **Tip:** To ensure the longest possible lifetime for the cleaner, inspect all of the parts for which servicing is detailed in the "4 Maintenance" section, once a month.

4.1 I Cleaning the cleaner and charging station

- The appliance must be cleaned regularly using clean or slightly soapy water. Do not use solvents.
- The charge plates under the cleaner and on the charging station must be cleaned regularly using a cloth or the scouring side of a kitchen sponge and fresh water. **Do not use metal sponges, metal brushes, solvents or salt water.**
- Rinse the appliance thoroughly with clean water.
- Do not let the appliance dry in the sun by the pool.

4.2 I Cleaning the filter



- The cleaner's performance may be reduced if the filter is full or dirty.
- Clean the filter with clean water after each cleaning cycle.
- Use the (black) fine debris filter only when using the cleaner for the first time or when it comes out of winter storage.

- If the filter is clogged, clean it with an acidic solution (spirit vinegar, for example). It is recommended that you do this at least once a year, since the filter will clog if not used for several months (winterising period).

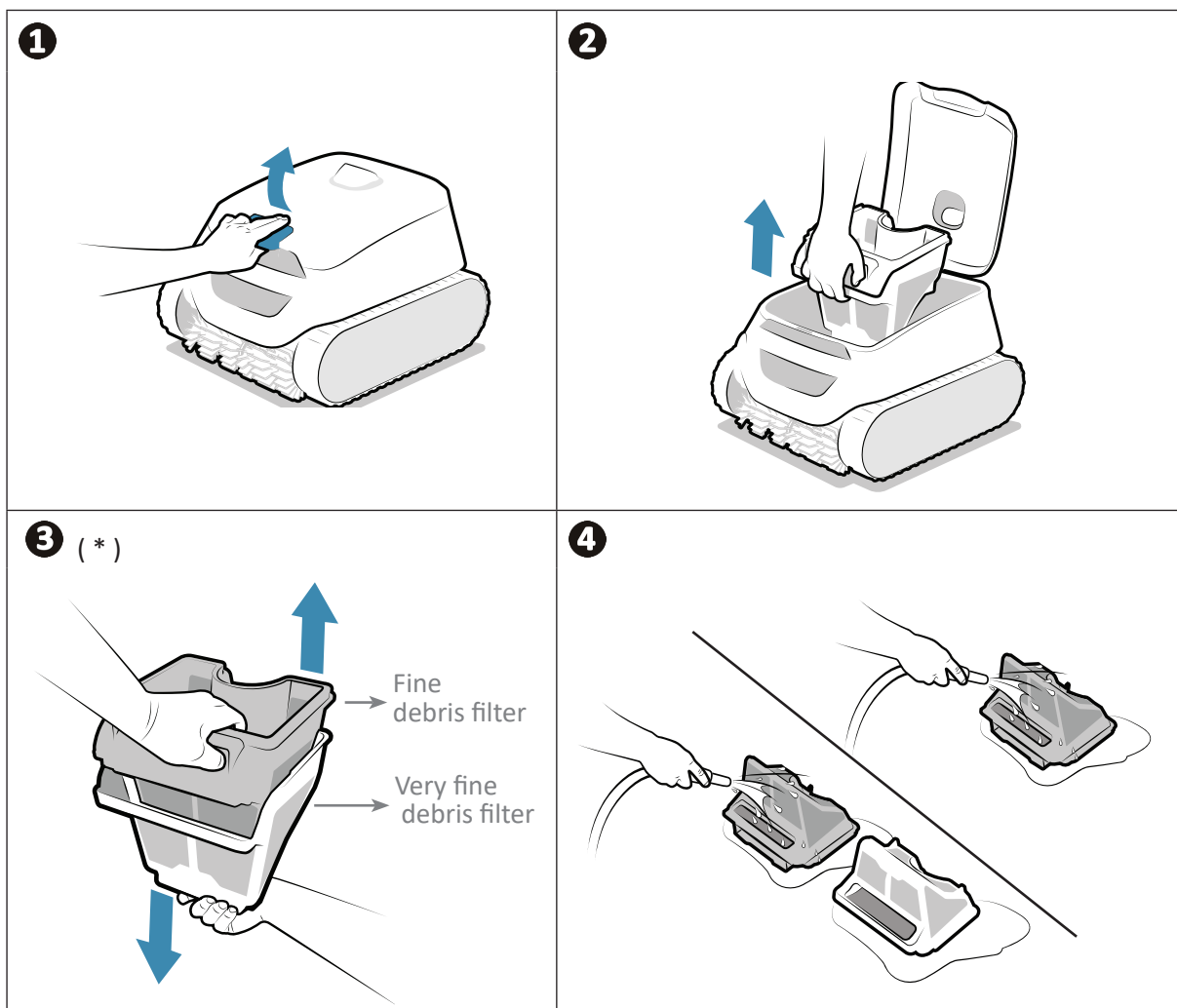

* Depending on the model

4.3 I Cleaning the brushes and the centre bridge



- The performance of the appliance may diminish if the brushes are too dirty or if debris or objects become trapped in the centre bridge (between the two brushes).

- Clean the brushes and the centre bridge in clean water as soon as the appliance is removed from the pool after each cleaning cycle. Do not wait for the debris to dry.
- Remove any object or debris trapped between the two brushes.

4.4 I Cleaning the cover seal



- Appliance performance may diminish if debris (mainly sand) becomes trapped under the cover seal, making it impossible to maintain the necessary waterproofing.

- Clean the cover seal in clean water as soon as the appliance is removed from the pool after each cleaning cycle. Do not wait for the debris to dry.



- **Tip: To preserve the integrity of the cleaner and guarantee optimum performance:**

- The filter and brushes should be replaced every two years,
- Checking the wear indicator on the tracks is recommended. Replace the tracks as soon as the indicator is reached.

4.5 | Cleaning the propeller



To avoid serious injury:

- Wear gloves when maintaining the propeller .
- Always dry the appliance before cleaning the propeller and clean the propeller in a dry area.
- Ensure cleaner is in the OFF mode before attempting maintenance (see the first step below).

Be careful to force the appliance to stop before cleaning the propeller: Check that the cleaner is completely off by moving the cursor : no indicator should light up.

- 1 Open the filter access hatch by pressing on the lock.
- 2 Remove the filter.
- 3 Unscrew the flow guide by hand. When it is first removed, it may be necessary to loosen it with a screwdriver.
- 4 Remove the flow guide by lifting it.
- 5 Put on a pair of gloves and pull the propeller, holding it firmly to take it out.

Remove all debris (leaves, stones, etc.) which may be blocking the propeller.

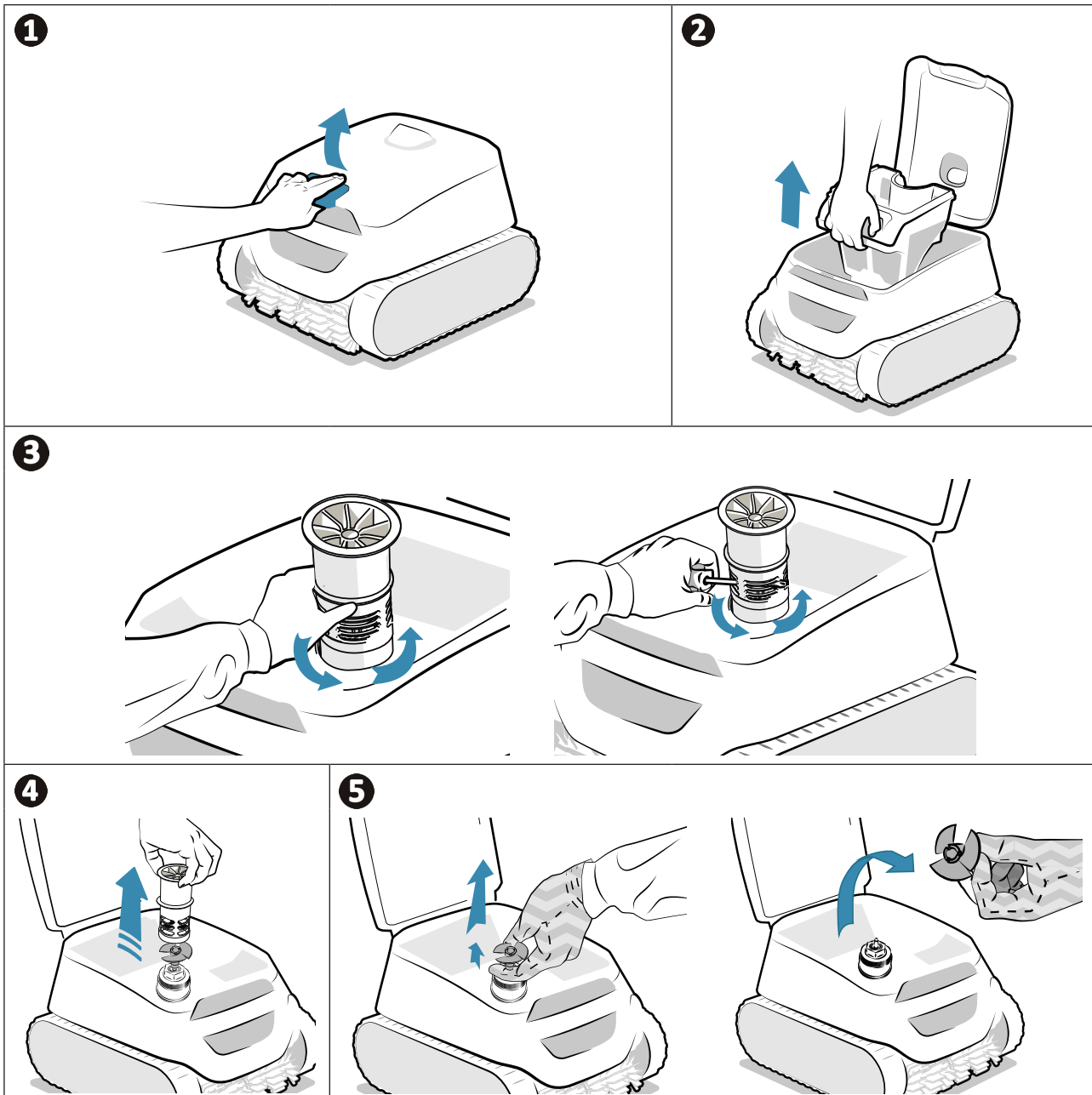

- Once cleaning is finished, put on a pair of gloves and firmly push the propeller back in place, put the flow guide back in, screwing it in by hand. Refit the filter.
- Place the cleaner on the charging station to wake it up.

4.6 I Replacing the brushes

Are the brushes worn?

- Replace the brushes if the wear indicators are similar to example **B** :

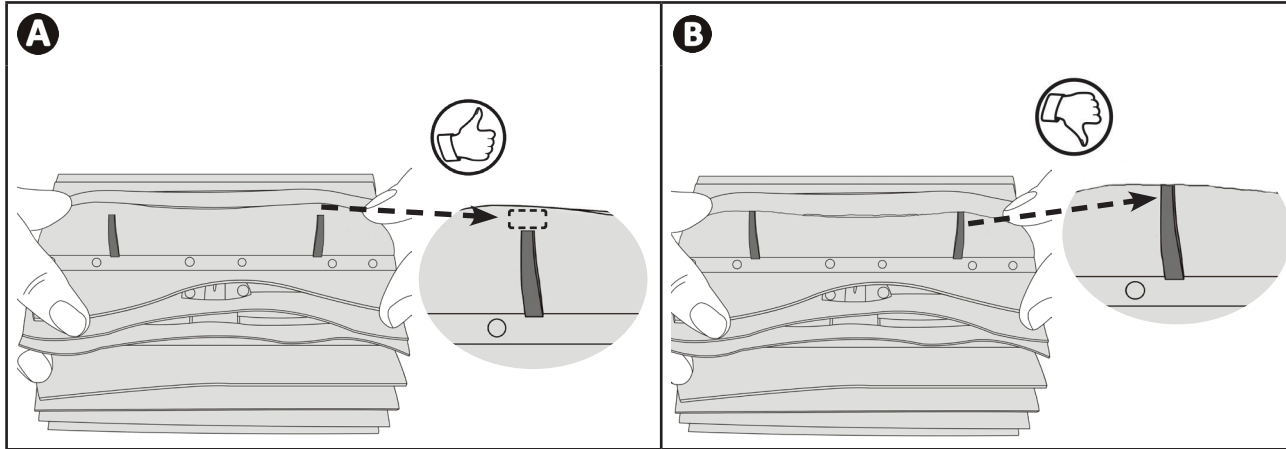

EN

Remove the worn brushes

- When the cleaner is not placed on the base, remove the tabs from the holes in which they are fastened, then remove the brushes.

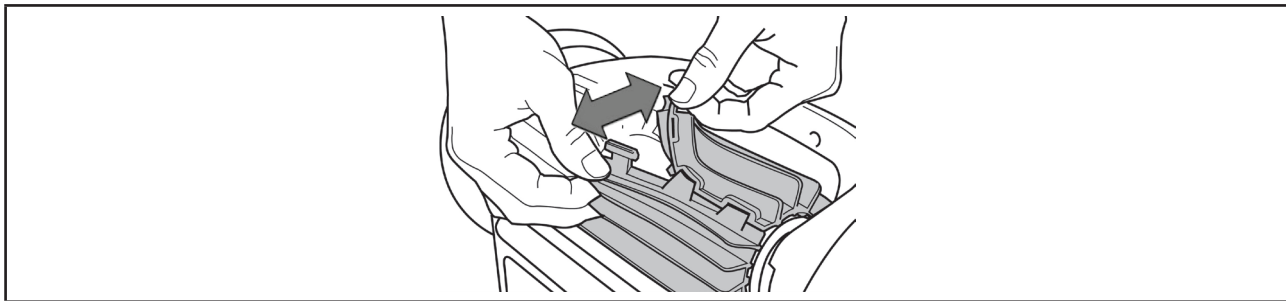

Position the new brushes.

- Fit the side without tabs under the brush holder (see figure **1**).
- Roll the brush around its support, slide the tabs into the attachment holes and pull on the end of each tab until its edge passes through the slit (see figure **2**).
- Cut the tabs using a pair of scissors for them to be level with the other blades (see figure **3**).

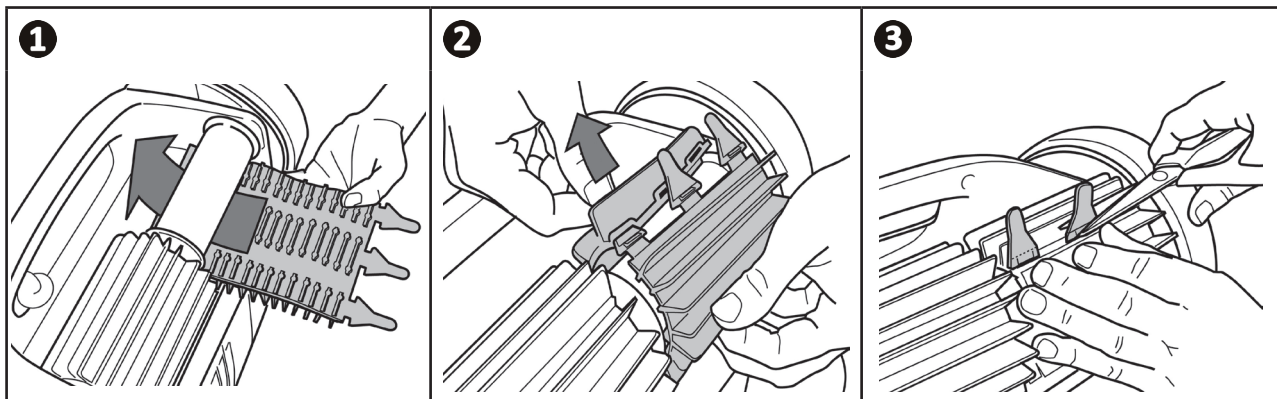

4.7 | Replacing the battery block



- The cleaner's battery block should only be replaced by a qualified professional: Contact your retailer



4.8 | Winterising



- DO NOT leave the cleaner uncharged before winterising.
- Make sure that the cleaner and the charge plates are clean and dry before charging.
- DO NOT leave cleaner in water when not in use.
- DO NOT expose cleaner to fire, excessive temperatures, ignition sources, or pool and spa chemicals.
- Store all the elements away from sunlight, humidity and bad weather.
- Store out of reach of children and pets.

- Before winterising, fully charge the cleaner to preserve the life of the battery: the  indicator changes to steady green as soon as the cleaner is fully charged.
- During winterising, the cleaner may:
 - Remain connected (so that it is ready to be used immediately at the start of the next season, with no need to recharge it first), or
 - Remain disconnected (then it must be recharged before it is used for the first time next season).

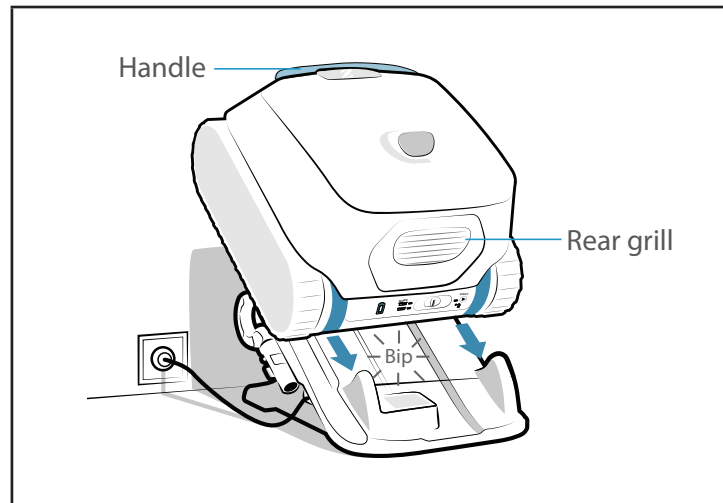



5 Troubleshooting



• Before you contact the retailer, carry out these few simple checks using the following tables if a problem occurs.

• If the problem is not resolved, contact your retailer.

• : Actions to be performed by a qualified technician only.









5.1 I Appliance behaviour

EN

Part of the pool is not correctly cleaned	<ul style="list-style-type: none"> • Repeat the immersion steps (see § "2.5 I Starting a cleaning cycle"), varying the immersion location until you find the right place in the pool. • The filter is full or dirty: clean it (see "4.2 I Cleaning the filter"). • The robot was not fully charged when starting the cycle so cycle has been shortened.
The appliance does not stay firmly on the pool floor or floats	<ul style="list-style-type: none"> • There is still air in the appliance's casing. Repeat the immersion operations (see "2.5 I Starting a cleaning cycle"). • The filter is full or dirty: clean it (see "4.2 I Cleaning the filter"). • If the filter remains clogged despite cleaning: replace it. • There are tiny bubbles all over the outside of the appliance: <ul style="list-style-type: none"> - And the water level is below the skimmers: adjust the water level. - And the water level is at the skimmers level: the plumbing is over oxygenated. Contact your retailer . • The propeller is damaged. Contact your retailer .
The appliance does not climb or no longer climbs the walls	<ul style="list-style-type: none"> • In Bottom/Walls/Waterline mode, the cleaner does not systematically climb the walls. The frequency varies during the cycle. • Check that the Floor/Walls/Waterline mode is chosen. • The filter is full or clogged: clean it with fresh water. If the filter is clogged, clean it with an acidic solution (spirit vinegar, for example). Replace the filter if necessary. In case of Dual filtration, try to use the fine debris filter (black) only. If it helps the appliance to climb, the filter needs to be replaced. • The tracks are slack: contact your retailer to replace them . • Clean the check valve without removing it. • Even though the water seems clear, microscopic algae are present in your pool. They are not visible to the naked eye, and they make the walls slippery and prevent the appliance from climbing. Carry out shock chlorination and slightly reduce the pH. Do not leave the appliance in the water during shock treatment.
The appliance does not collect debris	<ul style="list-style-type: none"> • The filter is full or dirty: clean it (see "4.2 I Cleaning the filter"). • If the filter remains clogged despite cleaning: replace it. • Debris / objects are stopping the filter valve from closing: contact your retailer . • Debris / objects are getting trapped in the centre bridge (between the two brushes) and are not being collected: Clean the brushes and the centre bridge. Clean them regularly. • Debris (mainly sand) is getting trapped in the cover seal: Clean the cover seal. Clean it after every cycle.
The appliance does not move on start-up.	<ul style="list-style-type: none"> • Check that the cleaner is charged (the battery indicator is green). • Check that a cleaning cycle has been launched and that the lights are on.
The two filters will not come apart	<ul style="list-style-type: none"> • An object / debris is jammed between the two filters stopping them from coming apart: Remove it.
All indicator lights are off	<ul style="list-style-type: none"> • The cleaner is asleep: slide the cursor to the left or right to wake it up. • If this does not work, place the cleaner back on the charging station. • If the lights remain off when the cleaner is on the charging station, contact the dealer .

If the problem continues contact your retailer:

5.2 I Charging station behaviour

Problem	Cleaner behaviour	Charging station behaviour	Solution
The cleaner needs recharging (first use or cleaner not charged) but it will not recharge.	The  indicator does not blink when the cleaner is on the charging station.	The charging station is connected but the indicator under the station is off or blinking (instead of being green) when the cleaner is placed on it.	<ul style="list-style-type: none"> The cleaner is badly positioned: reposition it. Check that the charging contacts on the cleaner and on the charging station are clean. If necessary, clean them with a cloth with fresh water (non salt water). The charging station is faulty: Contact your retailer 
		The indicator under the charging station is green when the cleaner is placed on it:	
		The charging station is working properly, with: <ul style="list-style-type: none"> - The plug is connected to the power outlet, - The indicator under the charging station is green when the cleaner is not placed on it, - The indicator under the charging station is red when the cleaner is placed on it. 	<ul style="list-style-type: none"> They are some deposits on the charge plates : clean the charge plates (located on the underside of the cleaner and on the station base) with a cloth and fresh water (non-salt water). The cleaner charge level is below the critical battery level: contact your retailer  The battery is obsolete and needs replacing: contact your retailer 
	The  indicator is blinking 4 times in red when the cleaner is on the charging station.		<ul style="list-style-type: none"> Clean the charge plates (located on the underside of the cleaner and on the station base) with a cloth and fresh water (non-salt water).
	The  indicator is blinking in orange for a few seconds or minutes then directly switch to steady green when the cleaner is on the charging station.		<ul style="list-style-type: none"> Remove the cleaner from the station. If the  indicator turns off instead of indicating the charge level of the cleaner: the battery is obsolete and needs replacing. Contact your retailer 

If the problem continues contact your retailer: 

5.3 I User alerts

- The indicators on the rear of the cleaner blink to report an alert to the user. Find which indicator is blinking and apply the suggested troubleshooting solutions.
- User are also accessible from the iAquaLink™ app.

Clearing an error code from the iAquaLink™ app:

- After following the troubleshooting solutions, press **Clear Error**.

5.3.1 Cleaner error





EN

"On/off"	Blinking red	Display in the iAquaLink™ app	Solutions
▶		Safety Shut-off Communication error	<ul style="list-style-type: none"> • The cleaner is in safe state. • The cleaner board is under power but does not respond. Contact your retailer
		Traction motor right Traction motor left Drive motor consumption right Drive motor consumption left	<ul style="list-style-type: none"> • Check that debris is not preventing the brushes or tracks from moving freely. • Rotate each wheel by a quarter of a turn in the same direction until it rotates smoothly. Repeat turning wheels in the opposite direction until rotation is smooth. • If this fails to solve the problem, contact your retailer for a full diagnosis.
		Cleaner out of the water	<ul style="list-style-type: none"> • Clean the filter thoroughly. • Put it back in the water, shaking to release the air bubbles. • Restart the cycle. • If this fails to solve the problem, contact your retailer for a full diagnosis.
		Pump motor	<ul style="list-style-type: none"> • Be careful to force the appliance to stop before cleaning the propeller: when the cleaner is not placed on the charging station, hold the cursor to the left until all the indicators go out (about 20 seconds). Check that the cleaner is completely off by moving the cursor : no indicator should light up. Then, check that no debris or hair is blocking the propeller. Cleaning must take place out of the water and the cleaner must be placed on a dry surface. • Clean the filter thoroughly. • If this fails to solve the problem, contact your retailer for a full diagnosis.
		Firmware Update Error	<ul style="list-style-type: none"> • Close the iAquaLink™ app. • Check that the cleaner is connected to the Wi-Fi network (the blue LED is on and steady). • If the indicator is not steady, open the iAquaLink™ app, select the cleaner and click on "Update".

If the problem continues contact your retailer:

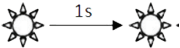

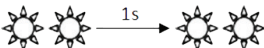
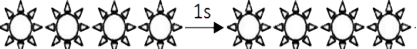
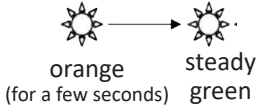

• If the cleaner stops before the end of its cycle but no indicator is blinking when it is removed from the water, place the cleaner on its charging station so that the indicator will start to blink.

5.3.2 Battery error

"On/off"	Blinking	Display in the iAquaLink™ app	Solutions
	 red	Battery Error	<ul style="list-style-type: none"> The battery block is faulty : Contact your retailer: 
	 red	Charging Error (Too hot) Charging Error (Too cold)	<ul style="list-style-type: none"> The temperature detected at the charging station location is outside of the recommended temperature range for recharging the cleaner (5°-35°C): Move the charging station.
	 red	Charging error	<ul style="list-style-type: none"> Clean the charge plates (located on the underside of the cleaner and on the station base) with a cloth and fresh water (non-salt water).
	<p>When the cleaner is on the charging station</p>  orange (for a few seconds) steady green	-	<ul style="list-style-type: none"> Remove the cleaner from the station. If the  indicator turns off instead of indicating the charge level of the cleaner: the battery is obsolete and needs replacing. Contact your retailer 

If the problem continues contact your retailer: 

5.4 I Troubleshooting the connection to the iAquaLink™ app

Connectivity status	Possible causes	Solutions
<ul style="list-style-type: none"> • The LED  is off. • The LED  is on but the Wi-Fi connection is non-existent (or spotty). The "Connection Error" message is displayed on the screen in the iAquaLink™ app. • A red dot appears in the "My appliances" list 	<ul style="list-style-type: none"> • Appliance not charged • Appliance not connected to Wi-Fi and/or internet connection lost • Weak Wi-Fi signal* 	<ul style="list-style-type: none"> • Check the internet connection - the network may be down. • Ensure that you have a sufficiently strong Wi-Fi signal. There are several ways to check the strength of the Wi-Fi signal: <ul style="list-style-type: none"> - Unplug the home Wi-Fi router, then plug it back in. - Using a laptop, go into Configuration Panel to see the status of your network connections. Check the strength of the Wi-Fi network signal on a laptop. - Install the iAquaLink™ app, using a smartphone or tablet. Check the strength of the Wi-Fi network signal. If the Wi-Fi network is weak, install a Wi-Fi extender. - Use an app dedicated to analysing the Wi-Fi connection: several are available in iOS or Android. • On first set-up, place the cleaner as close as possible to the home Wi-Fi router then repeat the configuration steps (see "3.1 I First-time cleaner configuration"). • If the  LED does not stop blinking, install a Wi-Fi extender. • If the dot is red when the cleaner is charged, the connection is working and the LED is on steady, refresh the screen (by swiping downwards). When the dot turns green: The appliance is ready for use.
<ul style="list-style-type: none"> • The  LED is blue and blinks quickly. A message is displayed in the app. 	<ul style="list-style-type: none"> • A software update is in progress. 	<ul style="list-style-type: none"> • Wait for the update to complete.

***There may be several reasons for a weak Wi-Fi signal**



- The distance between the router and cleaner,
- The type of router (box),
- The number of walls separating the router and the cleaner,
- The Internet service provider,
- etc.

EN

Votre revendeur
Your retailer

Modèle appareil
Appliance model

Numéro de série
Serial number

Pour plus d'informations, enregistrement produit et support client :
For more information, product registration and customer support:

www.zodiac.com

