

## User Manual

for the Measuring, Control, and Dosing System for Swimming Pools



**PoolManager® Chlorine**  
**PoolManager® Bromine**  
**PoolManager® Oxygen**  
**PoolManager® PRO**



## Content

<b>Part A: Overview</b> .....	<b>7</b>	9.2.9 Messages	20
<b>1 Identification of safety information</b> .....	<b>7</b>	9.2.10 Menu functions	21
1.1 Safety information .....	7	9.2.11 Menu sequences	21
1.2 Miscellaneous markings .....	7	9.3 Help .....	21
<b>2 General safety information</b> .....	<b>7</b>	9.4 Informational text .....	22
<b>3 New Functions</b> .....	<b>8</b>	9.5 Individualisation .....	22
<b>4 User qualification</b> .....	<b>8</b>	9.5.1 Menu style	22
<b>5 Term definitions</b> .....	<b>9</b>	9.5.2 Background image	23
<b>6 Standard access codes</b> .....	<b>9</b>	9.5.3 Icon style	23
<b>7 Overview</b> .....	<b>9</b>	<b>10 Measurement graph</b> .....	<b>23</b>
7.1 PoolManager® .....	9	10.1 Overview .....	23
7.2 PoolManager® maintenance programs .....	9	10.2 Notes on measurement graph: .....	24
7.3 Overview of features .....	10	10.3 Configuration .....	25
7.3.1 Display and operation	10	10.4 Measurement graph export .....	25
7.3.2 Measuring and control	10	<b>11 Water maintenance</b> .....	<b>25</b>
7.3.3 Safety functions	10	11.1 pH value .....	25
7.3.4 Add-on functions	11	11.2 Disinfection .....	26
7.3.5 Remote access from the local network or the Internet	11	11.2.1 PoolManager® PRO	26
7.3.6 Interfaces	12	11.2.2 Redox value (Disinfection with chlorine or bromine)	26
<b>Part B: Function description</b> .....	<b>12</b>	11.2.3 Correlation pH value and disinfection	26
<b>8 Remote access</b> .....	<b>12</b>	11.2.4 Active oxygen (Bayrosoft® Light)	27
8.1 Prerequisites .....	12	<b>12 Measurement, control, dosing (pH value, redox value, chlorine / bromine)</b> .....	<b>27</b>
8.2 Remote access to the local network .....	12	12.1 Function .....	27
8.2.1 Step by step	12	12.2 Dosing rate .....	27
8.3 Remote access from the Internet .....	12	12.3 Show in home view .....	28
8.3.1 Step by step	12	12.4 Configuration parameters .....	28
8.4 User login in remote access .....	13	12.4.1 Setpoint	28
8.5 Quick info .....	13	12.4.2 Lower alarm threshold	28
8.5.1 Calling up quick info	13	12.4.3 Upper alarm threshold	28
<b>9 Display and operation - Graphical user interface</b> .....	<b>13</b>	12.4.4 Proportional range	28
9.1 Important menus .....	14	12.4.5 Minimum dosing rate	29
9.1.1 Home view	14	12.4.6 Intelligent dosing monitoring	30
9.1.2 Main menu (icon menu)	15	12.4.7 Deadzone	30
9.1.3 Add-on functions menu (icon menu)	15	12.4.8 Dosing cycle	30
9.1.4 Mode menu	16	12.4.9 Dosing direction	30
9.2 Further menus (standard menus) .....	16	12.4.10 Recommended settings (PoolManager® Cl / Br / O2)	31
9.2.1 Basic concepts	16	12.4.11 Recommended settings (PoolManager® PRO)	31
9.2.2 Numerical parameters	17	12.5 Configuration Wizard .....	31
9.2.3 Selection parameters	17	12.5.1 Basics	31
9.2.4 Text parameter	18	12.5.2 Configuration Wizard	32
9.2.5 Time parameters	18	<b>13 Calibration (basic measurement adjustment)</b> .....	<b>32</b>
9.2.6 Date parameter	19	13.1 When is calibration necessary? .....	32
9.2.7 Access code	19	13.2 Calibration pH .....	32
9.2.8 Network (IP) addresses	20		

13.2.1	Calibration procedure	32	17.7.4	Use alarm relay	44
13.2.2	Calibration errors	33	17.8	Alarm relay	44
13.3	Calibration chlorine (Cl) / bromine (Br)	33	17.8.1	Electrical connection	44
13.3.1	Calibration procedure	34	<b>18</b>	<b>Service messages</b>	<b>45</b>
13.3.2	Calibration errors	34	18.1	Signalising due Service Messages	46
13.4	Calibration redox (mV)	35	18.2	Re-scheduling service messages	46
13.4.1	Calibration procedure	35	<b>19</b>	<b>Eventlog</b>	<b>46</b>
13.4.2	Calibration errors	35	19.1	Events	46
13.5	Determining the redox (mV) setpoint	35	19.2	Information displayed	46
13.5.1	Step by step	35	19.2.1	Event display	46
<b>14</b>	<b>Automatic dosing O2 (Bayrosoft® Light)</b>	<b>36</b>	19.2.2	Example, O2 (Bayrosoft® Light) dosing	47
14.1	Basic concept	36	<b>20</b>	<b>Controller settings</b>	<b>47</b>
14.1.1	Main dosing	36	20.1	Date & Time	47
14.1.2	Refresh dosing	36	<b>21</b>	<b>Service functions</b>	<b>48</b>
14.1.3	Progression of effective Bayrosoft® Light concentration	37	21.1	Management of system configurations	48
14.2	Show in Home view	38	<b>22</b>	<b>User management</b>	<b>48</b>
14.3	Main Menu O2 (Bayrosoft® Light)	38	22.1	Menu User Management	48
14.4	Configuration O2 (Bayrosoft® Light)	38	22.2	Users	49
14.5	Additional dosings	39	22.2.1	Standard users	49
<b>15</b>	<b>Temperature measurement</b>	<b>39</b>	22.2.2	Individual users	49
15.1	Overview	39	22.3	Overview of user rights	50
15.2	Measuring water temperature	39	22.4	Enable remote access for various functions	50
15.3	Measured temperatures	39	22.5	Adjust user levels for various functions	50
15.4	Sensor types	39	22.6	User login with access code	51
15.5	Show in the home view	40	22.6.1	User selection	51
15.6	Configuration temperature	40	<b>23</b>	<b>Communication &amp; Interfaces</b>	<b>52</b>
15.7	Calibration	40	23.1	Data import and export	52
<b>16</b>	<b>Manual dosing</b>	<b>40</b>	23.2	E-mail functions	53
16.1	Overview	40	<b>24</b>	<b>Add-on functions</b>	<b>53</b>
16.2	Menu manual dosing	40	<b>25</b>	<b>Universal switch outputs (4x)</b>	<b>53</b>
16.3	Blocking via alarms	41	25.1	Safety information	53
16.4	Special case, shock chlorination	41	25.2	Overview	53
16.5	Special case, pump test (pH / Cl / Br / mV / O2)	41	25.3	Configuration menu	54
<b>17</b>	<b>Safety functions and alarms</b>	<b>42</b>	25.3.1	Programmable timer	54
17.1	Overview	42	25.3.2	Basic configuration	54
17.2	Flow monitoring	42	25.3.3	Safety settings	55
17.2.1	Input terminal blocks for flow monitoring	42	25.4	Electrical connection	55
17.2.2	Automatic / manual acknowledgement	42	25.4.1	Connection options	56
17.3	Start delay	43	25.4.2	Lifespan of relay switching contacts	57
17.4	Alarm signalisation	43	<b>26</b>	<b>Filter pump control</b>	<b>57</b>
17.4.1	Alarm display in the "Home" view	43	26.1	Safety information	57
17.5	Blocking of dosing via alarms	43	26.2	Overview	57
17.6	Table overview	44	26.3	Menu Filter pump	58
17.7	Alarm settings	44	26.3.1	Programmable timer	58
17.7.1	Acoustic alarms	44	26.3.2	Basic configuration	58
17.7.2	Flow alarm settings	44	26.3.3	Safety settings	59
17.7.3	Level alarm settings	44	26.4	Electrical connection	60

<b>27 Flockmatic® pump</b> .....	<b>60</b>	36.5 PoolManager® installation .....	69
27.1 Safety information .....	60	36.5.1 Connection with the circulation system .....	69
27.2 Overview .....	60	36.5.2 Measurement system .....	70
27.3 Menu Flockmatic® pump .....	60	<b>37 Maintenance</b> .....	<b>70</b>
27.3.1 Programmable timer .....	61	37.1 Monthly maintenance .....	70
27.3.2 Basic configuration .....	61	37.2 Quarterly maintenance .....	70
27.4 Electrical connection .....	61	37.3 Annual maintenance .....	70
<b>28 Heating</b> .....	<b>61</b>	37.4 Cleaning.....	71
28.1 Overview .....	61	37.5 Dosing pump hose replacement .....	71
28.2 Temperature measurement .....	61	<b>38 Winter breaks</b> .....	<b>72</b>
28.3 Function .....	62	<b>39 Decommissioning</b> .....	<b>72</b>
28.4 Show in home view .....	62	<b>40 Commissioning</b> .....	<b>72</b>
28.5 Menu Heating .....	62	<b>41 Dosing pumps</b> .....	<b>73</b>
28.5.1 Basic configuration .....	62	41.1 Peristaltic pumps .....	73
28.5.2 Safety settings .....	63	41.1.1 Electrical connection .....	73
28.6 Electrical connection .....	63	41.1.2 Configuration .....	74
<b>29 Solar heating</b> .....	<b>63</b>	41.2 Membrane dosing pumps .....	74
29.1 Overview .....	63	41.2.1 Suitable membrane dosing pumps .....	74
29.2 Temperature measurement .....	63	41.2.2 Electrical connection .....	75
29.3 Function .....	63	41.2.3 Configuration .....	75
29.4 Show in "Home" view .....	63	<b>42 Changing the care method</b> .....	<b>76</b>
29.5 Menu Solar heating .....	64	<b>43 Software update</b> .....	<b>76</b>
29.5.1 Basic configuration .....	64	43.1 Step by step.....	76
29.5.2 Safety settings .....	64	<b>44 Network connection</b> .....	<b>77</b>
29.6 Electrical connection .....	64	44.1 Step by step.....	77
<b>30 Eco mode (energy saving mode)</b> .....	<b>65</b>	44.2 Options .....	77
30.1 Menu Eco mode .....	65	44.2.1 Wireless network (WLAN / WiFi) .....	77
30.1.1 Programmable timer .....	65	44.2.2 PowerLAN (dLAN) .....	78
30.1.2 Basic configuration .....	65	<b>45 Remote access to the PoolManager®</b> .....	<b>78</b>
30.1.3 Safety settings .....	66	45.1 Remote Access via BAYROL Web Portal .....	78
30.2 Electrical connection .....	66	45.2 Direct Access from the Internet without BAYROL Web Portal .....	78
<b>31 Universal switch inputs IN 1 ... IN 4</b> .....	<b>66</b>	45.3 Local network (IP) address .....	78
<b>32 Hardware resources (inputs and outputs)</b> .....	<b>66</b>	45.4 Menu Network (IP) configuration .....	79
<b>Part C: Installation, start-up, maintenance</b> .....	<b>67</b>	<b>46 Remote access from the Internet</b> .....	<b>80</b>
<b>33 Safety information for performing installation, start-up, and maintenance work</b> .....	<b>67</b>	46.1 Dynamic IP address resolution .....	80
<b>34 Wall mounting</b> .....	<b>67</b>	46.2 Step by step.....	81
34.1 Selecting the installation location.....	67	46.2.1 DynDNS account set-up .....	81
34.2 Installation .....	68	46.2.2 DynDNS configuration on a network router .....	81
<b>35 Electrical connection</b> .....	<b>68</b>	46.2.3 Port forwarding on the network router .....	81
35.1 Measurement grounding .....	68	46.3 Prerequisites and potential problems .....	81
35.2 Blocking via the circulation pump .....	68	46.4 Multiple PoolManagers® on one network.....	81
<b>36 Installation into the circulation system</b> .....	<b>68</b>	<b>47 Security for remote access</b> .....	<b>82</b>
36.1 PoolManager® Chlorine installation diagram .....	68	<b>48 Hardware description</b> .....	<b>82</b>
36.2 PoolManager® Oxygen installation diagram .....	68	48.1 System printed circuit board .....	82
36.3 PoolManager® Bromine installation diagram .....	69	48.2 CPU printed circuit board .....	83
36.4 PoolManager® PRO installation diagram .....	69	48.3 Connection terminals with spring contacts .....	83

48.3.1	Technical information	83
48.4	Electrical connections .....	83
48.4.1	External connections	83
48.4.2	Connection terminals	84
48.5	Power supply 230 V~ .....	85
48.6	Standard wiring (Without add-on functions).....	85
48.6.1	Connecting a temperature sensor	85
48.6.2	Connecting the flow switch	86
48.6.3	Connection of chlorine measuring cell	86
<b>49</b>	<b>Service measures on the unit .....</b>	<b>86</b>
49.1	Opening the casing .....	86
49.2	Opening the terminal box .....	86
49.3	Fuses .....	87
49.3.1	Fuse replacement	87
49.4	Replacing a relay .....	87
49.5	Replacing the buffer battery .....	87
49.6	Replacing the configuration module .....	88
<b>50</b>	<b>Installation of optional supplemental modules.....</b>	<b>88</b>
50.1	4x power outputs 4...20 mA: PM5-SA4 CONVERTER 4-20MA (Art. no. 127011) .....	88
<b>51</b>	<b>Troubleshooting.....</b>	<b>88</b>
<b>52</b>	<b>Technical data .....</b>	<b>90</b>
<b>53</b>	<b>EC Declaration of Conformity .....</b>	<b>91</b>
<b>54</b>	<b>UKCA Declaration of Conformity .....</b>	<b>92</b>

## Part A: Overview

### 1 Identification of safety information

#### 1.1 Safety information



**HAZARD!**  
**Hazard identification**  
 Hazard description  
**Description of (potential) consequences**  
 Measure to be undertaken in order to avoid this hazard.



**HAZARD DUE TO VOLTAGE!**  
**Hazard identification**  
 Hazard description  
**Description of (potential) consequences**  
 Measure to be undertaken in order to avoid this hazard.



**Required user qualification:**  
**USER QUALIFICATION (description)**  
 Explanatory text...

#### 1.2 Miscellaneous markings



**IMPORTANT NOTICE!**  
**Brief description**  
 Informational text...



**INFO**  
**Brief description**  
 Information...



**INFO**  
 The corresponding section applies only for the PoolManager® version(s) indicated



**TIP**  
**Brief description**  
 Tip...

- *Chapter name* (printed in italics) indicates a chapter within this document
- *Menu name* (printed in italics) indicates a menu in PoolManager®
- *Parameter name* (printed in italics) indicates a parameter in PoolManager®
- [n] (*designation*) indicates the number of a terminal block (in squared brackets) and its designation (printed in italics in round brackets)
- [Unit] indicates a physical unit, e.g. [°C] or [mg/l]

### 2 General safety information

This user manual has basic information that should be observed during assembly, start-up, operation, and maintenance. Therefore, this user manual absolutely must be read by installers and operators prior to assembly and start-up, and must be accessible to every user of this device. Additionally, all further safety information in this document absolutely must be observed.

Read and follow all instructions.

In order to minimise the danger of injury, do not allow children to use this product.

#### Hazards from non-compliance with safety information

Non-compliance with safety information can result in hazards to persons, the environment, and the equipment.

Non-compliance with safety information will result in a forfeit of any potential right to damage compensation.



**HAZARD!**  
**Unexpected start**

PoolManager® starts operation as soon as there is voltage on the incoming power line. It is possible that dosing pumps start or that add-on functions are turned on or switched.

**Potential consequence:** Death or the gravest degree of injury, heavy material damage.

- Be sure that PoolManager® is secured against unauthorised access.
- Do not supply PoolManager® with power until all preparations for a safe start and safe operation have been completed.



**HAZARD!**  
**Potential overdosing of maintenance products**

Despite PoolManager's® comprehensive safety functions, it's possible that a sensor failure and other errors could lead to an overdosing of maintenance products.

**Potential consequence:** Death or the gravest degree of injury, heavy material damage.

- Design your installation such that uncontrolled dosage is not possible in the event of a sensor failure or other errors, and/or such that uncontrolled dosage is recognised and halted before damage is incurred.



**HAZARD!**  
**Gaseous chlorine produced from dosing in standing water if dosing outputs are not locked via the filter pump**

If the flow switch is stuck or experiences another error, there is a risk of dosing into standing water. Poisonous chlorine gas can be yielded when sodium hypochlorite and pH minus come together.

**Potential consequence:** Death or the gravest degree of injury, heavy material damage.

- Only run power to input L<sub>D</sub> [35] / N<sub>D</sub> [36] for the dosing outputs if circulation is running (dosing outputs must be locked via the filter pump).
- Connect power input L<sub>D</sub> [35] / N<sub>D</sub> [36] to the timer that controls the filter pump or use the corresponding outlet on the filter pump.
- If PoolManager® is controlling the filter pump directly, then locking automatically occurs internally.
- Please also refer to the Section 230V~ Power Supply.



**HAZARD!**

**Compliance with safety class**

If the housing or individual cable glands have not been properly closed after working on the PoolManager® such that a reliable seal has been secured, then it will be possible for moisture to penetrate into the device.

**Potential consequence: Damage or destruction to PoolManager®, malfunctions.**

- Be sure the unit is safely sealed again after performing any kind of work.

**3 New Functions**

The internal software (firmware) of the PoolManager® is continued to be developed. New software versions may provide new, extended or improved functions, which are not described in this version of the user manual.



**HAZARD!**

**Use of new functions**

Because of the continued development, a PoolManager® controller may contain functions, which are not or not completely described in this version of the user manual.

The use of such new or extended functions without a profound and secure understanding by the operator may result in malfunctions and severe problems.

**Potential consequence: Death or the gravest degree of injury, heavy material damage.**

- Make sure to get a profound and secure understanding of a function and relevant boundary conditions before you start to use it.
- Check for an updated version of the user manual or additional documentation available for the relevant functions.
- Make use of the integrated help function of the PoolManager® to get detailed information on functions and their parameter settings.
- In case it should not be possible to get a profound and secure understanding of a function based on the available documentation, do not use this function.

**4 User qualification**



**HAZARD!**

**Insufficient personnel qualification**

Hazards in the event of insufficiently qualified personnel

**Potential consequence: Death or the gravest degree of injury, heavy material damage.**

- The system operator must ensure compliance with the required qualification level.
- Any and all work may only be performed by correspondingly qualified personnel.
- Access to the system must be prevented for insufficiently qualified persons, e.g., via access codes and passwords.

Designation	Definition
Instructed person	An instructed person is someone who has been informed of and, as necessary, trained in the assigned tasks and the potentially associated hazards, and has been notified of the required safety equipment and measures.
Trained user	A trained user is someone who meets the requirements for an instructed person and has additionally received training specific to the system.
Trained specialist	A trained specialist is someone who meets the requirements of a trained user and additionally can assess assigned work tasks and recognise potential hazards based on training, knowledge, and experience as well as on familiarity with relevant norms and provisions. Multiple years of work experience in the respective field may also be assessed as specialised training.
Electrical specialist	An electrical specialist is someone who is capable of performing work on electrical systems and independently recognising and avoiding potential hazards based on specialist training, knowledge, and experience as well as familiarity with the relevant norms and provisions. An electrical specialist must meet the provisions in the applicable legal stipulations regarding accident prevention.
IT specialist	An IT specialist (IT = information technology) is someone who is capable of performing work on computer systems, networks, and network components and independently recognising and avoiding potential hazards based on professional training, knowledge, and experience as well as on familiarity with the relevant norms and provisions.



**IMPORTANT NOTICE!**

The system operator must ensure compliance with the relevant accident prevention conditions, with all legal regulations, and with the generally recognised technical safety principles!



## 5 Term definitions

- **Bromine (Br)**  
Active bromine (free bromine) in pools for disinfection, measured in [mg/l]
- **Chlorine (Cl)**  
Active chlorine (free chlorine) in pools for disinfection, measured in [mg/l]
- **Default value**  
Standard setting
- **Dosing pumps**  
Used in the sense of "dosing pumps and other dosing equipment"
- **Ethernet**  
Cable-connected standard TCP/IP network.
- **Flow**  
Measured water's flow through the measuring chamber
- **IP address**  
Device address within a TCP/IP network, e.g., in the World Wide Web (IP = Internet Protocol). An IP address consists of four blocks of digits separated by dots, e.g., 192.168.10.1
- **Network**  
Computer network that uses TCP/IP protocol The Internet is also a TCP/IP network. PoolManager® is integrated into a TCP/IP network.
- **Oxygen (O2)**  
Disinfection with active oxygen (Bayrosoft® Light)
- **Redox potential (mV)**  
Indirect measured variable for disinfection in pools, measured in [mV] (also redox voltage or oxidation reduction potential (ORP))
- **TCP/IP**  
Standard protocol used on computer networks and on the Internet (TCP = Transmission Control Protocol, IP = Internet Protocol).
- **URL**  
Uniform Resource Locator = Web address, internet address, e.g., www.myPoolManager.com
- **Web**  
World Wide Web (Internet, www)
- **Web browser**  
Standard program for viewing websites (e.g., on a PC or on a mobile device), also used for remote access to PoolManager®.
- **WebGUI**  
Web-(Internet)-based graphical user interface (GUI = Graphical User Interface)
- **Web server**  
Program that transmits webpages to a browser. PoolManager® has an integrated web server accessible to browsers.
- **WLAN or WiFi**  
Wireless TCP/IP network / radio network (WLAN = Wireless Local Area Network).

## 6 Standard access codes

The following table indicates the standard default access codes.



### HAZARD!

#### Unauthorised access possible from using known access codes

Access codes facilitate access to critical areas on the system. Unauthorised access can lead to dangerous configurations.

#### Potential consequence: Death or the gravest degree of injury, heavy material damage.

- Configure individualised access codes. Under no circumstances should the preconfigured standard access codes be used.
- Keep access codes strictly confidential.

Users	Default access code (Must be changed!)
Customer (level 1)	1234
Customer (level 2)	5678
Service (level 3)	8642

## 7 Overview

### 7.1 PoolManager®

PoolManager® is a highly advanced measuring, control, and dosing system for swimming pools.

### 7.2 PoolManager® maintenance programs

You can select from among various maintenance programs in the PoolManager® family for your swimming pool:

- PoolManager® Chlorine (Cl)  
(disinfection with active chlorine, measurement and control of redox potential)
- PoolManager® Bromine (Br)  
(disinfection with active bromine, measurement and control of redox potential)
- PoolManager® Oxygen (O2)  
(disinfection with active oxygen (Bayrosoft® Light), automatic dosing system with temperature compensation)
- PoolManager® PRO  
(Disinfection with active chlorine or bromine, direct measurement and control of free chlorine or bromine)

### 7.3 Overview of features

#### 7.3.1 Display and operation

Great emphasis was placed on easy-to-follow, simple, and intuitive operation while developing PoolManager®. The screen design is also presented in a modern and attractive manner.

The following is an overview of the significant features and concepts in the graphic interface.



- Large, high-resolution 7" (18 cm) colour TFT graphics display
- Attractive 16:10 wide format
- Wide VGA resolution (800x400)
- 65536 colours
- Energy-saving LED backlight



- Simple, intuitive touchscreen operation**
- Robust touchscreen with additional full design foil overlay
  - Every touch is confirmed with a signal tone



- Icon menu**
- Up to 20 high quality icons
  - Faster and easier access to all functions and parameters
  - Additional text for each icon in order to ensure clarity

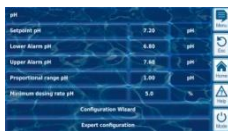

- Standard menu**
- Uniform concept for all standard menus
  - Uniform operation throughout



- Hotkeys**
- 5 hotkeys for menu navigation and for important basic functions that are regularly needed (e.g., help function)

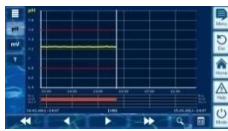

- Measurement graph**
- Max record length of 1 year
  - Max resolution 1 min
  - Display of 1 or 2 measured variables
  - Display of all important alarm statuses

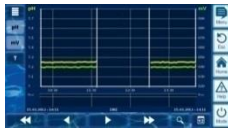

- Mode menu**
- Called up using special Mode hotkey
  - Various system functions can be turned on and off quickly and easily



- Numerous menu languages available**
- Extensive support for special international characters and complete character sets (e.g., Cyrillic and Greek)



- Individualisation**
- Selectable menu style
  - Selectable background image
  - Selectable icon style



#### 7.3.2 Measuring and control

- pH and redox measurement via single rod measuring cells (glass electrodes)
- free chlorine / bromine measurement via open potentiostatic measurement (3-electrode system)
- Temperature measurement in the measuring chamber (PT1000 sensor)
- 2 additional temperature inputs for additional functions (PT1000, KTY83, or KTY16-6 sensors)
- Proportional control for all control modules
- Minimum dosing rate provides for additional I-(integral) contribution i.e., for reliable attainment of the setpoint.
- All-important control parameters are individually programmable for each control module (setpoint, alarm thresholds, proportional range, dead zone (pH), dosing cycle time, minimum dosing rate, dosing monitoring)
- Continuous display of current dosing rate
- Conversion of all measured variables via high resolution 10-bit A/D converter.
- 1- or 2-point calibration for pH
- Simple and precise 1-point calibration for chlorine / bromine (PoolManager® PRO only)
- 1-point calibration for redox (mV) and temperature

#### 7.3.3 Safety functions

##### Extensive monitoring and alarm functions

- Upper and lower measured value alarms
- Flow monitoring
- Level warnings and level alarms (canister level)
- Dosing monitoring (monitoring of the attainment towards the setpoint)
- Battery alarm (buffer battery for the real-time clock)
- Start delay after turning on PoolManager® or after turning circulation back on
- Automatic blocking of dosing in critical alarm states and during start delay
- Alarm signalisation via
  - Screen display
  - Acoustic alarm (can be deactivated)
  - Alarm relay
- Continuous monitoring of correct program operation and automatic reset in the event of an error.

### 7.3.4 Add-on functions

#### Extensive add-on functions

- **4 universal switching outputs**  
Flexible control of water attractions and other applications:
  - Free name selection
  - Freely programmable timers
  - Optional link with other inputs and outputs
  - Optional link with external switches or push-buttons
- **Filter pump**  
Flexible control of the filter pump:
  - Up to 3 operating modes for variable filter pumps (eco mode, normal mode, increased mode)
  - Freely programmable timers
  - Flexibly configurable blocking of dosing
  - Optional link with external switches  
Interface via relay switching outputs or 4-20 mA current loop (optional)
- **Flockmatic® pump**  
Flockmatic® pump control:
  - Freely programmable timers
  - Configurable dosing rate
- **Heating**  
Flexible control of a pool heating:
  - Optional link with external switch
  - Optional combination with solar heating (solar priority)
  - Optional block via an input
- **Solar heating**  
Flexible control of a solar heating:
  - Optional link with external switch
  - Optional combination with pool heating (solar priority)
  - Optional block via an input
- **Eco mode**  
Flexible control of switching between a normal operation mode of the pool and an energy-saving eco mode (e.g., circulation via overflow in normal mode, or via floor drain in eco mode):
  - Freely programmable timers
  - Interface via relay switching output
  - Optional link with external switches or push-buttons



#### IMPORTANT NOTICE!

##### Limited number of inputs and outputs

The number of outputs and inputs available in the PoolManager® controller is limited due to space limitations.

Therefore, only a limited number of add-on functions can be used at the same time. The number of available outputs and inputs can be increased by the use of external extension boxes ("feature boxes"). This allows for the use of more add-on functions. With feature boxes, it is also possible to use *all* add-on functions at the same time, if necessary.

### 7.3.5 Remote access from the local network or the Internet

PoolManager® graphical user interface is based entirely on the most recent standard Internet (Web) technologies.

For that reason, it is also called a *WebGUI*:

- Web stands for Internet technologies
- GUI stands for graphical user interface

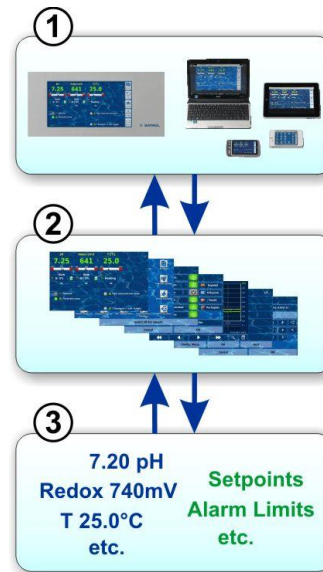

#### 1 Web browser

The user interface is displayed by a Web browser. There is a browser running locally on the PoolManager® unit, while simultaneously additional browsers may be running on the widest variety of devices on the local network or on the Internet that may access PoolManager®.

#### 2 Web server

The Web server delivers requested menu pages to all connected Web browsers.

#### 3 Data server

The data server manages and stores all PoolManager® data (measured values, system status, configuration parameters) and makes it available to the Web server.

PoolManager® WebGUI facilitates complete and entirely transparent remote access from a local network (TCP/IP, Ethernet) or from the Internet. Transparent remote access means that the user interface looks exactly like it does locally on the PoolManager® unit and is operated identically.

Certain restrictions in remote access are required only for security reasons.

Remote access can be realised with any mobile or stationary device that is connected to PoolManager® via a network or the Internet and that runs a standard Web browser. This prerequisite is fulfilled from the start by an ever-growing number of modern systems.

#### Suitable devices and systems for remote access



#### All types of PCs, such as:

- Desktop PCs, notebooks, netbooks
- Home / media centre PCs
- PCs with a Microsoft Windows® operating system
- Apple iMac® or MacBook® PCs
- PCs with a Linux operating system



#### Smartphones, such as:

- Apple iPhone®



- Smartphones with a Google Android® operating system
- Smartphones with a Windows® operating system
- BlackBerry® smartphones



### Tablet PCs, such as:

- Apple iPad®
- Tablet PCs with a Google Android® operating system (e.g., Samsung Galaxy Tab®)



### Web-compatible TV devices

(Or TV devices that are used as a PC screen)

### Building management systems

Building management systems (BMS) and touch panels for living areas can be used for remote access to PoolManager® if they have a modern standard Web browser.

### 7.3.6 Interfaces

#### Measurement inputs:

- pH (BNC connector)
- 3x temperature (PT1000 or KTY83 sensor)

Depending on the controller model:

- Cl / Br (potentiostatic 3-electrode system)
- Redox potential (BNC connector)

#### Switching inputs:

- Flow switch (measuring water circuit), optional pressure switch (main circulation circuit)
- 2 level inputs for pH and disinfection (canister level)
- 4 additional switching inputs for additional functions

#### Relay outputs:

- 3 dosage relays (pH-Minus, pH-Plus, disinfection). Unused dosing relays may be used for add-on functions, alternatively.
- Alarm relay (may be used for add-on functions, alternatively)
- 4 relays (OUT1...OUT4) for add-on functions

Every single relay output can be individually configured as a 230 VAC output or volt-free switch.

#### Communication interfaces:

- Ethernet LAN (RJ45 connector)
- Internal USB interface for memory sticks (also used for software updates)
- CAN bus for external feature boxes

#### Optional plug-in modules (up to 3)

- 4x power output 4-20 mA
- Additional plug-in modules may be available in the future as required

## Part B: Function description



### Required user qualification: TRAINED USER

All activities described in Part B may only be performed by trained users as defined in the Chapter *User Qualification*.

## 8 Remote access

PoolManager® offers comprehensive and comfortable opportunities for remote access from a local network or from the Internet.

### 8.1 Prerequisites

In order to make use of these opportunities, PoolManager® first has to be connected with a network. Then remote access has to be configured.

The required steps are described in *Part C* and have to be performed by an IT specialist.

There you will find all required information for remote access to PoolManager®.

Additionally, remote access has to be released for one or multiple users in user management. Username and password must be assigned to the corresponding users to enable remote access.

See *User Management*.

### 8.2 Remote access to the local network

For remote access from the local network, you generally require the local network (IP) address of your PoolManager®. That could be, for example, 192.168.1.99.

#### 8.2.1 Step by step

1. For remote access from the local network, first start the Web browser on a PC or on another mobile or stationary device on the same network as PoolManager®.
2. Enter your PoolManager's® **IP address** into the **browser's address bar**. For some browsers, you'll have to enter `http://` at the beginning. Other browsers supplement it automatically: `http://192.168.1.99` (for example)

### 8.3 Remote access from the Internet

For remote access from the Internet, you generally need a URL (uniform resource locator = "Web address"). That could be, for example, `http://myPoolManager.dtdns.net`.

#### 8.3.1 Step by step

1. For remote access from the Internet, first start the browser on a PC or on another mobile or stationary device that is connected to the Internet.
2. Enter PoolManager® **URL** into the **browser's address bar**. For some browsers, you'll have to enter `http://` at the beginning. Other browsers supplement it automatically: `http://myPoolManager.dtdns.net` (for example)



**TIP**

**Setting up a favourite**

In order to simplify access to PoolManager®, you can set the corresponding IP address or URL as a favourite in your Web browser and give it an appropriate name.

This makes remote access to PoolManager® quick and easy via the browser's favourites list.

For a detailed description, please refer to the documentation of the corresponding browser.



**Info**

**HTML 5 support**

In order to use the full scope of functions for remote access to PoolManager®, the browser being used has to support the current HTML 5 standard.



**Info**

**JavaScript**

For remote access to PoolManager®, JavaScript has to be activated in the Web browser being used.

This usually is the case in the standard configuration of all popular Web browsers.

**8.4 User login in remote access**

When connecting to PoolManager® via remote access, a login window first appears in which you have to authenticate yourself by entering a valid username and the correct password for the username entered.

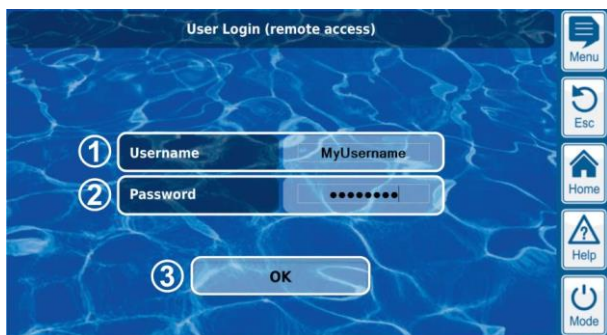

- 1 Enter the username for remote access
- 2 Enter the password for the username entered
- 3 OK will confirm the entries and, after successful authentication, start PoolManager® user interface.



**INFO**

**Entry via remote device's keyboard**

In this login window, the accessing device's keyboard (e.g., PC keyboard or standard screen keyboard on a smartphone) is used to enter username and password, not the PoolManager® screen keyboard.

**8.5 Quick info**

PoolManager® provides a compact info field (Quick info) with the most important information:



The following information is shown:

- PoolManager® device name
- Current measured value
- Text colour on measured values:  
green Everything OK  
red There is at least one alarm pending

Pressing (or clicking) on the quick info field starts full remote access to the corresponding PoolManager® controller.

**8.5.1 Calling up quick info**

To call up quick info, the normal address for remote access (IP address or URL) is attached along with the following suffix:

`/cgi-bin/webgui.fcgi?infoframe=0`

Thus, a complete URL would be, for example

`http://myPoolManager.dtdns.net/cgi-bin/webgui.fcgi?infoframe=0`

This URL is relatively complicated, but it can easily be stored in the browser as a favourite.



**TIP**

**Multiple devices at a glance**

If you are a specialist in charge of multiple PoolManager® units, you can have the quick info of all relevant devices displayed jointly on one webpage. To do so, you could e.g., design a simple HTML webpage (frame page) locally on your PC which shows clearly arranged the quick infos of all relevant controllers.

This means you'll have the most important information from all controllers in one place.

If, for example, there is a controller showing an alarm (red text), then you can directly access that controller with one click.

**9 Display and operation - Graphical user interface**



Display and operation are realised on a large TFT colour display with touchscreen. The function shown can be executed with the simple tap of a finger on the corresponding area on the screen. Each tap on the touchscreen is confirmed with a signal tone.

To the right of the display, there are 5 "hotkeys" for important standard functions. The hotkey functions are also selected with a simple finger tap and confirmed with a signal tone.



**Menu (main menu)**

Direct jump to main menu (icon menu)

**Esc (escape)**

Back to previous menu level

**Home (home view)**

Direct jump to home view



**Help**  
Display help text for the current menu

**Mode (mode menu)**  
Direct jump into mode menu for turning on or off various functions quickly and easily. When main-menu is entered pressing the menu-hotkey for a second time activates/deactivates the background image in transparent style.

- Sufficient volume available
- Limited residual volume available
- The canister is empty and has to be replaced

**9.1 Important menus**

**9.1.1 Home view**

Home view is the standard view that can usually be seen on the screen and provides an overview of all important data and operating statuses. Home view can be called up at any time using the "Home" hotkey.

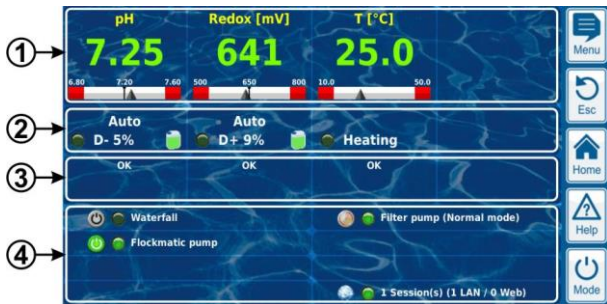

- 1 Measured value display with additional graphic measured value scale
- 2 Operating status and dosage status
- 3 Alarms
- 4 Add-on functions

The areas 1, 2, and 3 in one column mutually relate to a measurement or control module, such as pH, redox, chlorine, or temperature.

**1 Measured value display with graphic measured value scale**

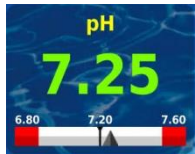

Colour of measured value display:  
**green** Normal operation, everything OK  
**yellow** Dosage blocked (missing flow signal and/or start delay)  
**red** Alarm, dosage blocked!

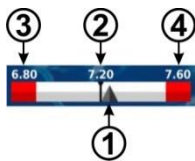

- 1 Current measured value (arrow)
- 2 Setpoint (numeral value and mark)
- 3 Lower alarm threshold
- 4 Upper alarm threshold

**2 Operating status and dosage status**



- 1 Operating mode or operating status
- 2 LED indicates whether the dosing pump is currently running
- 3 Dosing direction  
D- Decrease the measured value  
D+ Increase the measured value
- 4 Current dosing rate as %  
Example: 10 % means that the dosing pump is turned on for 10 % of the available time. It will then run, for example, for 6s if the dosing cycle is set to 60s.
- 5 Fill level in the corresponding canister:

Operating mode / operating status	
Auto	Measuring, control, and dosing run in automatic mode
Manual	Manual dosage is running
Off	Control is turned off
Alarm	Dosing is blocked by an alarm
Flow	Dosing is blocked because there is no flow signal present
Level	Dosing is blocked by a level alarm
Delay	Dosing is blocked because start delay is running
Dosage	PoolManager® O2 (Bayrossoft® Light) only: Automatic dosage is running

The corresponding field for temperature measurement shows the operating state for heating and/or solar heating if these add-on functions are being used

**3 Alarms**



Active alarms for the corresponding module are displayed or 'OK' if there are no alarms pending.

**4 Add-on functions**

In the add-on functions area in the home view, the most important information for all current active add-on functions is shown. The content of this area is adjusted automatically such that all active add-on functions can be seen (max. of 8).



- 1 Symbol for current operating mode
  - Timer operation
  - Function turned off
  - Function turned on
- 2 LED displays whether the add-on function is currently turned on
- 3 Name of the add-on function and, if applicable, further information on current operating status



**NOTE**  
**No touch operation in home view**

In order to avoid accidental erroneous commands, home view does not react to taps on the touchscreen. To configure settings or to move to other menus, first use the hotkey to call up the main menu.





















### 9.1.2 Main menu (icon menu)

The main menu can be called up at any time using the Menu hotkey. It facilitates direct access to all important system functions.



Every function is represented by an icon with supplemental text (The set of icons shown depend on the controller model).

-  **Measurement Graph**  
Display of graphic measurement progression
-  **Alarm Overview**  
Display and acknowledgement of alarms
-  **Alarm Settings**  
Settings for alarms and their signalisation
-  **Service Messages**  
Display and acknowledgement of service information (e.g., notification when electrode replacement needed)
-  **Eventlog**  
Display of important events and incidents
-  **Configuration pH**  
Settings for pH measurement and control
-  **Configuration redox (mV)**  
Settings for redox (mV) measurement and control
-  **Configuration Cl (chlorine) / Br (bromine)**  
Settings for chlorine / bromine measurement and control
-  **Configuration O2 (Bayrosoft® Light)**  
Settings for O2 (Bayrosoft® Light) automatic dosing
-  **Configuration Temperature**  
Settings for temperature measurement
-  **Calibration pH**  
pH measurement calibration
-  **Calibration redox (mV)**  
redox (mV) measurement calibration
-  **Calibration Cl (chlorine) / Br (bromine)**  
Chlorine / bromine measurement calibration
-  **Calibration Temperature**  
Temperature measurement base calibration
-  **Manual dosage pH**  
Manually controlled addition of pH minus (or pH plus)
-  **Manual Dosage redox (mV)**  
Manually controlled addition of chlorine / bromine
-  **Manual Dosage Cl (chlorine) / Br (bromine)**  
Manually controlled addition of chlorine / bromine
-  **Manual Dosage O2 (Bayrosoft® Light)**

Manually controlled addition of O2 (Bayrosoft® Light)



- Device Settings**
- Basic controller settings
  - Menu language
  - Individualisation of user interface
  - Controller name
  - Date & time
  - Power down mode



- Service Functions**  
Special functions (trained specialists only):
- Pool volume
  - Configuration of dosing pumps
  - Reset to defaults
  - Software update (from USB stick)
  - Commissioning step-by-step
  - Controller model and care method
  - Trade show settings



- User Management**  
Configuration of all user data, access data, and access rights for local operation at the unit and for remote access



- Communication & Interfaces**
- Data import and export (measurement graph, etc.)
  - Network (IP) configuration
  - E-mail configuration
  - Configuration of all further interfaces



- Add-on functions**  
Call-up icon menu for add-on functions

### 9.1.3 Add-on functions menu (icon menu)

The add-on functions menu is called up from the main menu. It facilitates access to all add-on functions.



Each add-on function is represented by an icon with supplemental text.



- Switch output 1, 2, 3, 4**
- Flexible control of water attractions and other applications:
  - Free name selection
  - Freely programmable timers
  - Optional link with other inputs and outputs
  - Optional link with external switches or push-buttons





**Filter pump**

- Flexible control of the filter pump:
- 3 potential operating modes for variable filter pumps (eco mode, normal mode, increased mode)
  - Freely programmable timers
  - Flexibly configurable blocking of dosing
  - Optional link with external switches
  - Interface via relay switching outputs or 4-20 mA current loop (optional)



**Flockmatic® pump**

- Flockmatic® pump control:
- Freely programmable timers
  - Configurable dosing rate



**Heating**

- Flexible control of pool heating:
- Optional link with external switch
  - Optional combination with solar heating (solar priority)
  - Optional block via an input



**Solar heating**

- Flexible control of solar heating:
- Optional link with external switch
  - Optional combination with pool heating (solar priority)
  - Optional block via an input



**Eco Mode**

- Flexible control of switching between a normal operation mode of the pool and an energy-saving eco mode (e.g. circulation via overflow in normal mode, or via floor drain in eco mode):
- Freely programmable timers
  - Interface via relay switching output
  - Optional link with external switches or push-buttons

**9.1.4 Mode menu**

The mode menu can be called up at any time using the Mode hotkey. It makes it possible to turn most system functions on and off and to set the operating mode quickly and easily. Each function is shown on one line within the mode menu.



- 1 Description of the function
- 2 Configured operating mode (operating modes depend upon the corresponding function). The operating mode can also be changed here.
- 3 Buttons for turning a function on and off quickly  
**Green button** The function is turned on.  
 Touching the button turns the function off.  
**Grey button** The function is turned off.  
 Touching the button turns the function on.
- 4 Joint button for turning off ALL functions shown in the mode menu (emergency stop).

**Button function**

<b>Button off</b>	The function is definitely turned off (regardless of the operating mode set)
<b>Button on</b>	The function is automatically turned on and off depending on the operating mode set (e.g., time controlled). 'Button on' does NOT necessarily lead to the function being turned on immediately.



**Info**

**Return to time-controlled operation**

If the buttons in the Mode menu are used to turn a function on or off, while this function is in the "Time switch" operating mode, the function automatically returns to time-controlled operation at the next programmed switching point.



**TIP**

**Use buttons for turning on and off directly**

In order to use the buttons for turning functions on and off directly, set the function's operating mode to 'on.' In this configuration, the buttons in the mode menu switch directly between 'on' and 'off'.

**9.2 Further menus (standard menus)**

Most menus, by far, consist of multiple recurring standard elements, which can be combined with each other in a menu as desired. That is why this menu type is referred to as standard menu.



**9.2.1 Basic concepts**

**Max. 8 lines**

Each menu consists of a max. of 8 lines (Menu title and max. 7 standard elements).

**Menu title**

The first line always contains the menu title.

**Buttons and text fields**

In general, there are buttons and text fields in all menus. Buttons are shown with a subtle 3D effect. Text fields do not have the 3D effect. You can actuate buttons by lightly tapping on the touchscreen, thereby triggering the underlying function. Text fields, however, only display information and cannot be actuated.

**Help function**

Tapping on a parameter name will make a help text for that parameter appear.

**Parameter configuration**

Tapping on a parameter value will open an entry screen and the respective parameter can be configured.



The various standard elements are described in the following sections.

### 9.2.2 Numerical parameters

A numerical parameter is a numerical value. A numerical parameter can be changed by the operator, in case it is a configuration parameter. However, there are also numerical parameters that are displayed only and cannot be changed, e.g., measured values.



- 1 **Parameter name (button)**  
Calls up the parameter's help text
- 2 **Parameter value (button or text field)**  
If the parameter is configurable, then the parameter value will be shown as a button. That will call up an entry screen in which the value can be configured.
- 3 **Physical unit (text field)**

#### 9.2.2.1 Entry screen

There is one uniform entry screen for all numerical parameters, in which values can be configured.



- 1 Parameter name
  - 2 Display of current setting (or current input)
  - 3 Number block for entering the value
  - 4 Minimum potential setting
  - 5 Maximum potential setting
  - 6 Button for resetting to the default value
  - 7 Cancel will close the entry screen. The value will remain unchanged.
  - 8 OK will apply the configured value and save it permanently.
- Incremental increase or decrease of the configured value.
  - A sensible step size is automatically set for each parameter.
  - Delete the last character
  - Delete the entire value

### 9.2.3 Selection parameters

For selection parameters, one of multiple settings can be selected, e.g. 'active' or 'inactive'. The selection usually can be configured by the user. However, there are also selection parameters that are only displayed, but cannot be configured, such as system status.



- 1 **Parameter name (button)**  
Calls up the parameter's help text
- 2 **Parameter value (button or text field)**  
If the parameter is configurable, then the parameter value will be shown as a button. That will call up an entry screen in which the value can be configured.

#### 9.2.3.1 Entry screen

There is one uniform entry screen for all selection parameters which is used to change selection parameter settings.

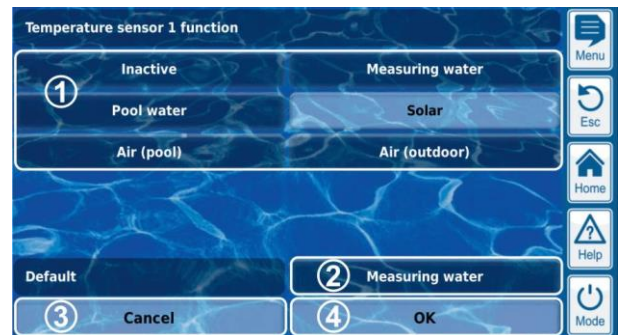

- 1 Display of all selection options.  
Tap on the desired option to activate it.
- 2 Button for resetting to the default value
- 3 Cancel will close the entry screen. The value will remain unchanged.
- 4 OK will apply the configured setting and save it permanently.

There are also selection parameters for which multiple selections are possible, such as multiple weekdays on which a certain process should be launched.



In this case, each selection option can be activated and deactivated by tapping on it.

For several selection parameters, a symbol is shown for each selection option in addition to the text, such as a flag to select the menu language.



### 9.2.4 Text parameter

A text parameter represents a text that you can enter, e.g., a name for the controller or for a function.



- 1 **Parameter name (button)**  
Calls up the parameter's help text
- 2 **Text (button)**  
Calls up an entry screen in which the text can be entered.

#### 9.2.4.1 Entry screen

There is a uniform entry screen with a screen keyboard for all text parameters in which the desired text can be entered.





#### INFO Deleting the current text

Once you start entering a text, the current text will be automatically deleted.

- 1 Display of current text (or current input)
- 2 Keyboard area for text input
- 3 Cancel will close the entry screen. The text will remain unchanged.
- 4 OK will apply the text entered and save it permanently.



Delete the last character

There are a total of four different keyboard layouts available that can be switched using the keys  and  as follows:



**Standard keyboard layout 1:**  
Lower case letters and numbers

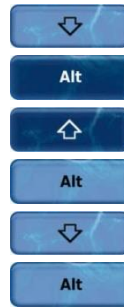

#### Standard keyboard layout 2:

Upper case letters and standard special characters



#### Alternative keyboard layout 1:

International special characters (lower case letters) and numbers



#### Alternative keyboard layout 2:

International special characters (upper case letters) and numbers



#### INFO

#### International keyboard layouts

If you set the language menu to Russian or Greek, then the characters available on the screen keyboard will be automatically adjusted accordingly.

### 9.2.5 Time parameters

Time parameters are used to enter and display a time, e.g., the current clock time or a specific time for a waterfall feature to run.



- 1 **Parameter name (button)**  
Calls up the parameter's help text
- 2 **Time (button)**  
Calls up the entry screen for time.

#### 9.2.5.1 Entry screen

There is one uniform entry screen for all time parameters in which a time can be set.



- 1 Display of current setting (or current input)
- 2 Incremental increase or decrease in hours
- 3 Incremental increase or decrease in minutes
- 4 Incremental increase or decrease in seconds
- 5 Cancel will close the entry screen. The value will remain unchanged.
- 6 OK will apply the time set and save it permanently.



Delete the last number



Delete the entire time



**INFO**

**Setting the system time**

When setting the system time, the internal real-time clock is set to the configured time by pressing the OK button.

**9.2.6 Date parameter**

Date parameters are used to enter and display a date.



- 1 **Parameter name (button)**  
Calls up the parameter's help text
- 2 **Date (button)**  
Calls up the entry screen for date.

**9.2.6.1 Entry screen**

There is one uniform entry screen for all date parameters, in which a date can be set.



- 1 Display of current setting (or current input)
- 2 Incremental increase or decrease by day
- 3 Incremental increase or decrease by month
- 4 Incremental increase or decrease by year
- 5 Cancel will close the entry screen. The value will remain unchanged.
- 6 OK will apply the date set and save it permanently.

- Delete the last number
- Delete the entire date

**9.2.7 Access code**

There are various access codes for menu access.



- 1 **Parameter name (button)**  
Calls up the parameter's help text
- 2 **Access code (button)**  
Calls up the entry screen for the access code.



**HAZARD!**

**Unauthorised access possible from using known access codes**

Access codes facilitate access to critical areas on the system. Unauthorised access can lead to dangerous configurations.

**Potential consequence: Death or the gravest degree of injury, heavy material damage.**

- Configure individualised access codes. Under no circumstances should the preconfigured standard access codes be used.
- Keep access codes strictly confidential.



**IMPORTANT NOTICE!**

**Availability of access codes**

Ensure that all access codes are known and available as needed, even after longer periods of time. The access codes are absolutely necessary for numerous functions and settings!



**INFO**

**Screen display**

In order to protect the confidentiality of an access code, the configured value is masked.



9.2.7.1 Entry screen

There is one uniform entry screen for setting an access code.



- 1 Display of an input mask for the access code.  
x stands for a number that has already been entered.  
\* stands for a number yet to be entered.
- 2 Pressing this button will show the actual access code instead of the input mask. Pressing it again switches back to the mask.
- 3 Cancel will close the entry screen.  
The value will remain unchanged.
- 4 OK will apply the configured value and save it permanently.



Delete the last number



Delete the entire access code

9.2.8 Network (IP) addresses

Various network addresses are entered into the network configuration (IP addresses, IP = Internet protocol).



1

2

1 **Parameter name (button)**

Calls up the parameter's help text

2 **IP address (button)**

Calls up the entry screen for the network (IP) address.



**INFO**

**IP addresses**

A network (IP) address always consists of 4 number blocks separated from each other with a dot. Each one of the 4 number blocks can have a value in the range of 0..255, such as 192.168.10.8.

9.2.8.1 Entry screen

There is one uniform entry screen for all network (IP) addresses in which the address can be configured.

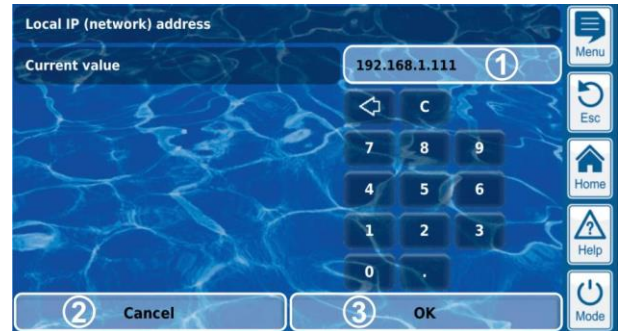

- 1 Display of current IP address (or current input)
- 2 Cancel will close the entry screen.  
The IP address will remain unchanged.
- 3 OK will apply the configured IP address and save it permanently.



Delete the last number



Delete the entire network (IP) address

9.2.9 Messages

Various messages are displayed within the menus. One typical example would be alarm messages.

The general format is unified for all messages and appears as follows:



1 **Message text (button)**

Calls up the message's help text

2 **Function call-up (button)**

Calls up a function that is assigned to the message, such as acknowledging ("quit") an alarm message.



**INFO**

**Optional function call-up**

The function call-up for a message is optional. There are also messages without function call-up, and messages for which the function call-up is only displayed under certain circumstances.

For example, if you acknowledge an alarm message, then the corresponding button will disappear.

### 9.2.10 Menu functions

In some menus, one or multiple menu functions are offered in the bottom line.

Each menu function is represented by a button. Pressing the button calls up the corresponding function.

Example: Function for starting a manual dosage:

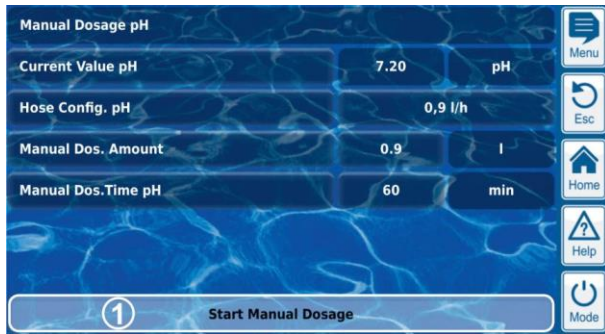

- 1 Menu function (button)**  
Calls up the corresponding function

### 9.2.11 Menu sequences

There are several functions that are realised via menu sequences, i.e. via a series of menus that are run through one after another step-by-step.

Example: Calibration



- 1 Name of menu sequence (text field)**
- 2 Menu no. within the menu sequence (text field)**  
Example: 2/3 means that the current menu is the second of a total of three within the menu sequence.
- 3 Navigation buttons (buttons)**  
Buttons for navigating within the menu sequence (calling up the next menu and/or the previous menu) and for cancelling the menu sequence.

### 9.3 Help

Help text is available for each menu and each parameter.



**TIP**

#### Active use of the help function

The integrated help function is the easiest way to receive further contextual information on a certain menu, parameter, or function. One touch of key is sufficient.

That is why it is recommended to use the help function actively and often.

#### Calling up the help function:

##### For menus



Pressing the Help hotkey

##### For parameters



Tapping on the parameter name in a standard menu, or pressing the Help hotkey in the entry screen of a parameter



- 1 Name of the parameter or menu that the help text refers to (text field)**
- 2 Help text (text field)**
- 3 OK button (button)**  
Closes the help text.
- 4 Display of the current system time (text field)**  
All help menus show the current system time and the system date.

### 9.4 Informational text

During menu navigation, informational text is shown in many areas that, for example, provide you with information on a function or on potential hazards.

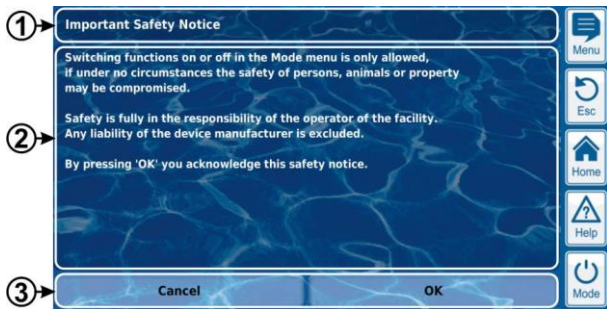

- 1 Title (text field)
- 2 Informational text (text field)
- 3 Functions (buttons)

Pressing a function button will close the informational text. Most informational text is confirmed with OK. For some informational text, especially safety advice, you have the option to continue a process by pressing OK or to cancel it.



#### HAZARD!

#### Non-compliance with informational text

There is a great deal of informational text indicating hazards and their avoidance. Not observing informational text may lead to hazards.

#### Potential consequence: Death or the gravest degree of injury, heavy material damage.

- Read all informational text carefully.
- Cancel the process if you are unable to exclude all potential hazards.

### 9.5 Individualisation

The user interface provides numerous opportunities for individualisation. The various individualisation options can be found in the following menu:



Controller settings

#### 9.5.1 Menu style

There are several attractive menu styles to choose from: Menu styles provide consistent and harmonious presentation of all PoolManager® menus in the visualisation style chosen.



Metallic style



Transparent style (with selectable background image)



Blue style

Note: The menu styles available may change and further styles may be added. The *menu style* setting in the *controller settings* menu provides you with all styles currently available:

#### 9.5.1.1 Transparent style

The *transparent style* offers particularly attractive display possibilities. Buttons and other menu elements are designed in a partially transparent manner. Thus, a freely selectable background image can be used in *transparent style* that shines through the semi-transparent menu elements in all menus.



#### INFO

##### Menu transitions in transparent style

Menu transitions take a bit longer when using *transparent style* because the extensive transparency calculations require a great deal of computing power.

This is only noticeable when operating the PoolManager® locally. In remote access, display is realised on the remote device and therefore does not require the PoolManager® computing resources.



#### TIP

##### Turning off the background image

If you would like to ensure menu transitions occur as quickly as possible, then you can change to style other than *transparent style*.

If you would like to use *transparent style* with its attractive display options, then there is the following option for optimising menu transitions:

Enter main menu by pressing the Menu hotkey .



Press the menu hotkey  again. This deactivates the background image temporarily and replaces it with a mono-colour background.



The mono-colour background provides for faster menu transitions. You can reactivate the background image later by calling up the main menu and pressing the Menu hotkey  again there.

It is particularly sensible to use this function if you want to make extensive configurations in the menus.



### 9.5.2 Background image

There are various background images available for *transparent style*. It is also possible to upload one's own background images to PoolManager®.

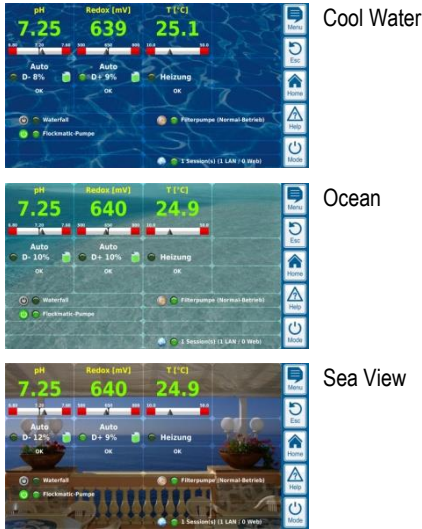

Note: The background images shown are intended as examples only. The *background image* setting in the *controller settings* menu shows you all background images currently available.

### 9.5.3 Icon style

There are several icon styles to choose from: Icon style determines the visualisation of icons in the main menu and in the *add-on functions* icon menu.



Note: The icon styles available may change and further styles may be added. The *icon style* setting in the *controller settings* menu shows you all icon styles currently available.

## 10 Measurement graph

### 10.1 Overview

PoolManager® internally saves all relevant measured values, alarm status, power on and off, and important parameter changes throughout the time frame of one year.

For the time frame of one month, a complete minute-by-minute dataset is available. For prior months, the data volume is reduced to one dataset per 15 minutes.

After one year has passed, the oldest data in the database are overwritten with current data.

The measurement graph can be called up at any time as follows:



Stored data can be graphically displayed on the controller at any time. Remote access to the measurement graph is also possible without restriction (prerequisite: The browser must support HTML 5).





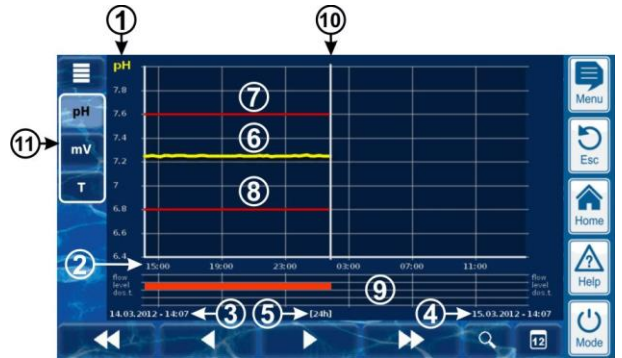

The following display variations can be selected:

- Display of one measured variable with alarm thresholds and complete alarm status.
- Joint display of two measured variables without alarm thresholds and only with flow status.

The following figure provides an overview of the measurement graph:



- 1 Scale for the measured variable shown (e.g., pH)
- 2 Time scale with times
- 3 Start date and time for the measurement graph currently displayed (date and time on the left edge)
- 4 End date and time for the measurement graph currently displayed (date and time on the right edge)
- 5 Time range currently displayed [1h] / [4h] / [12h] / [24h] / [1 week]
- 6 Measured value curve
- 7 Upper alarm threshold
- 8 Lower alarm threshold
- 9 Alarm status (flow / level / dosage alarm)  
An alarm is indicated by a red bar in the respective time frame.
- 10 Current point in time (= end of measurement graph)
- 11 Selection keys for showing one or two measured variables.  
Pressing a key activates or deactivates display of the respective measured variable.  
The measured variables currently displayed have a light background.  
A maximum of 2 measured variables can be activated (it may be necessary to deactivate a measured variable first before another can be activated)

-  Slow scroll forward and/or backward along the time axis by one half screen width, i.e., for example, by 12 hours if the screen displays 24 hours.
-  Slow scroll backward and/or forward along the time axis by one half screen width, i.e., for example, by 12 hours if the screen displays 24 hours.
-  Quick scroll forward and/or backward along the time axis by one full screen width, i.e., for example, by 24 hours if the screen displays 24 hours.
-  Quick scroll backward and/or forward along the time axis by one full screen width, i.e., for example, by 24 hours if the screen displays 24 hours.
-  Zoom function - opens a selection menu for the time frame being displayed:  
1h / 4h / 12h / 24h / 1 week
-  Go to date - Opens entry screen for a date. After entering the date and confirming, the measurement graph jumps directly to the date indicated.
-  Menu - Opens the configuration menu for the measurement graph

**Measurement graph with mutual display of two measured variables (e.g., pH and redox (mV)):**

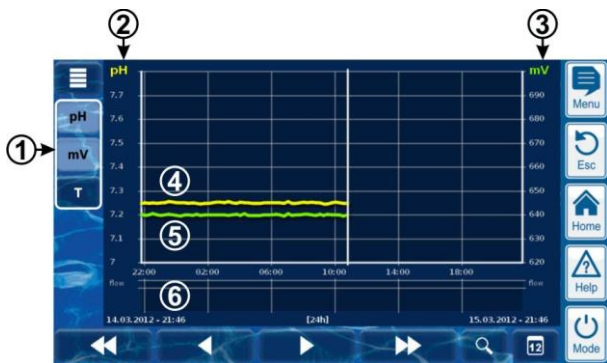

- 1 Selection keys for showing one or two measured variables  
Pressing a key activates or deactivates display of the respective measured variable.  
The measured variables currently displayed have a light background.  
A maximum of 2 measured variables can be activated (it may be necessary to deactivate a measured variable first before another can be activated)
- 2 Scale for the first measured variable shown (e.g., pH)
- 3 Scale for the second measured variable shown (e.g., mV)
- 4 Measured value curve for the first measured variable (e.g. pH)
- 5 Measured value curve for the second measured variable (e.g. mV)
- 6 Alarm status (flow only)  
A missing flow signal (flow alarm) is indicated with a red bar in the corresponding time frame.

**Measurement graph with break (PoolManager® was turned off):**

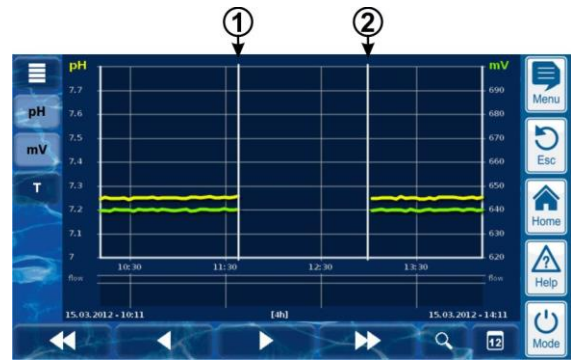

- 1 Point in time turned off
- 2 Point in time turned on

The device was turned off between point in time 1 and point in time 2. That is why there are no measured values shown for that range.

**Measurement graph (Bayrosoft® Light):**

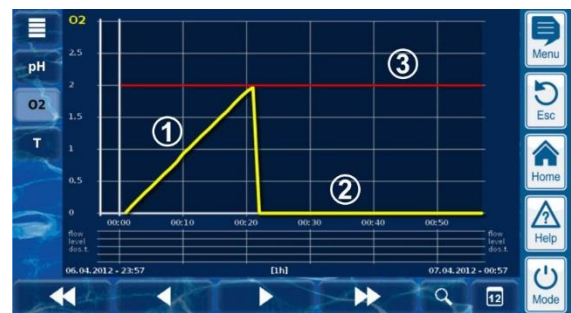

- 1 During O2 (Bayrosoft® Light) dosing, the current dosage volume is displayed in litres. The measured value curve climbs from 0 to the total dosage volume. In this example, that number is 2 litres.
- 2 The measured value curve shows 0 litres for times at which no dosage is applied.
- 3 For better orientation, the programmed basic dosage volume is shown.

**10.2 Notes on measurement graph:**

The value range displayed (measured value scale) is set automatically in order to ensure optimal display of the corresponding situation. The value range can also be set manually as needed. However, we recommend using automatic scaling.

- The following alarm statuses are indicated in the measurement graph.

Alarm	Designation
No flow signal (flow alarm)	Flow
Level alarm	Level
Dosing alarm	Dos.

- Alarms are displayed for as long as they are active. It does not matter whether they were acknowledged or not.



### 10.3 Configuration

The *configuration measurement graph* menu is called up from the measurement graph using the menu button .

The following table shows the menu contents:

Menu configuration measurement graph	
Configuration measurement graph pH	Call-up configuration for the pH measurement graph
Configuration measurement graph redox (mV)	Call-up configuration for the redox (mV) measurement graph
Configuration measurement graph Chlorine	Call-up configuration for the Chlorine (Cl) measurement graph
Configuration measurement graph Temperature (T)	Call-up configuration for the T (temperature) measurement graph
Configuration measurement graph O <sub>2</sub> Bayrosoft® Light)	Call-up configuration for the O <sub>2</sub> (Bayrosoft® Light) measurement graph
Export measurement graph	See section Measurement graph export

The menus for configuring the individual measurement graphs are all uniformly set-up as follows:

Menu configuration measurement graph pH / mV / Cl / T / O <sub>2</sub>	
Scaling auto / hand	Automatic or manual scaling for the display range, i.e., for the measured value scale. We recommend always using automatic scaling.
Display range min.	Minimum value of the measured value scale (manual scaling only)
Display range max.	Maximum value of the measured value scale (manual scaling only)

### 10.4 Measurement graph export

The menu *export measurement graph* provides various options for exporting the measurement graph

This menu can be called up at any time as follows:

- From the measurement graph using the menu button 
- or
- In the menu  *Communication & Interfaces*, sub-menu *Data Import and Export*

The menu provides the following functions:

Menu Export Measurement Graph
<b>Download measurement graphs from the controller</b>
For remote access from PC only! In remote access, saved measurement graphs can be downloaded from PoolManager® and saved locally on the remote PC in PDF format. The selection of measurement graphs is made by entering the start and end date.
<b>Save measurement graphs to USB stick</b>
Saved measurement graphs can be stored locally to a USB memory stick in PDF format. The selection of measurement graphs is made by entering the start and end date.
<b>Automatic saving of measurement graph</b>
Activation of automatic daily saving of measurement graphs.
<b>Automatic e-mail transmission of measurement graph</b>
Activation and configuration of regular automatic transmission of saved measurement graphs to up to 3 e-mail recipients

## 11 Water maintenance

The PoolManager® most important function is continuous measurement and automatic correction of pH value and disinfection of pool water. This is how PoolManager® always ensures optimal water quality.

### 11.1 pH value

The pH value indicates whether the water is in a neutral, acidic, or alkaline range. The pH scale usually ranges from pH 0 to pH 14.

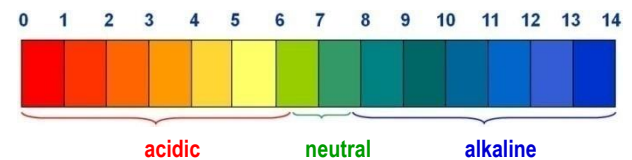

The basic requirement for optimal water quality is a pH value in the neutral range.

#### Ideal pH range for pool water:

- 7.0 to 7.4

#### Potential consequences of a pH value that is too low (acidic):

- Metal corrosion
- Attack on tile joints
- Skin and eye irritation
- Poor flocculation
- Deposition of carbonate hardness (pH value fluctuations)

#### Potential consequences of a pH value that is too high (alkaline):

- Reduction in disinfection effectiveness (for chlorine and bromine)
- Skin and eye irritation
- Tendency for lime scale deposits
- Poor flocculation

PoolManager® continuously measures the current pH value in the pool and compares the measured value with the desired pH value, which is configured as a setpoint.

If there is a deviation, then PoolManager® activates the pH dosing pump in order to quickly and precisely adjust the pool water's pH value to match the setpoint by adding pH minus (pH reducer) or pH plus (pH elevator).

#### Dosing direction pH minus (pH-)

Depending on the water quality and other general conditions, the pH value increases in most swimming pool applications as time passes. In order to counteract that rise, pH-Minus (pH reducer) is added. In this case, one speaks of the dosing direction pH-Minus (pH-).

#### Dosing direction pH-Plus (pH+)

Depending on the water quality and other general conditions, the pH value decreases in some swimming pool applications as time passes. In order to counteract that decrease, pH-Plus (pH elevator) is added. In this case, one speaks of the dosing direction pH-Plus (pH+).

#### Double-sided dosing (pH- / pH+)

It is possible to combine both dosing directions with each other. In this case, PoolManager's® pH control triggers two dosing pumps; one for pH-Minus and one for pH-Plus.

## 11.2 Disinfection

Alternatively, there are three water disinfection variations available for PoolManager®:

### Disinfection with active chlorine

(Measurement and control of redox potential)

### Disinfection with active bromine

(Measurement and control of redox potential)

### Disinfection with active oxygen

(Automatic dosing with temperature compensation)

### 11.2.1 PoolManager® PRO



#### INFO

This section applies for the PoolManager® PRO model only.

For the PoolManager® PRO, disinfection can be performed with active chlorine or active bromine. Both of these disinfectants can be measured and controlled with PoolManager® PRO's potentiostatic measuring cell.

PoolManager® PRO's potentiostatic chlorine measurement directly records the portion of free chlorine / bromine in the pool that is effective for disinfection. This is the hypochlorous acid HOCl. Depending on pH value, only a certain portion of free chlorine is present as HOCl; please refer to the section *Correlation pH value and disinfection*.

### 11.2.2 Redox value (Disinfection with chlorine or bromine)



#### INFO

This section applies for the models PoolManager® Cl and PoolManager® Br only.

The redox value of the pool water represents an electric potential (electrical voltage) that can be measured using a corresponding electrode (redox electrode).

The redox potential is a measure for the water's oxidation potential, and therefore for the current disinfection effectiveness.

The redox value is a sum parameter that can be influenced by numerous substances in the pool water.

#### Oxidizing substances (disinfectants) raise the redox value

- Hypochlorous acid HOCl for disinfection with active chlorine
- Hypobromous acid HOBr for disinfection with active bromine

#### Reducing substances (contaminants) lower the redox value

- Inorganic and organic contaminants
- Chloramines, oils, carbamide, sweat, germs, bacteria, algae, leaves, etc.

Due to these numerous influences, it is not possible to determine the exact chlorine / bromine level in the pool directly from the redox value measured. It is, however, possible to set the desired chlorine / bromine value in the pool and then to calculate the associated redox value.



#### IMPORTANT NOTICE!

##### Determining the correct redox value

For different pools with the same chlorine value or bromine value, the redox value may be widely different. For example, a chlorine value of 0.8 mg/l can lead to a redox value of 720 mV in one pool, while in another pool, it can lead to a redox value of 780 mV.

- Do not rely on values seen in the past. Rather, determine the correct redox value for each pool individually.

The determined redox value for the desired chlorine / bromine value is configured as a setpoint in PoolManager®. The control system ensures

that the redox value remains consistently on level with the configured setpoint.

As long as there are no significant changes in other influential variables, the consistent redox value simultaneously provides for a constant chlorine / bromine level in the pool, thereby ensuring reliable disinfection.

### 11.2.3 Correlation pH value and disinfection



#### INFO

This section applies for the models PoolManager® Cl, PoolManager® Br and PoolManager® PRO only.



The basic prerequisite for reliable and stable disinfection with chlorine and bromine is a constant and optimally adjusted pH value in the pool.

There are two significant reasons for this:

For high pH values over 7.5, the proportion of free chlorine present as hypochlorous acid (HOCl) drops dramatically. Since, however, only hypochlorous acid is effective for disinfection, disinfection effectiveness reduces in the same dimension. Sufficient disinfection is no longer ensured.

Free chlorine measurement, and also the redox signal measured, are not dependent upon the level of all available free chlorine, but rather influenced only by the hypochlorous acid, which is effective for disinfection. If, however, the proportion of hypochlorous acid changes due to a fluctuating pH value, then that will necessarily lead to a fluctuating redox value. Stable and reliable disinfection is then no longer possible.

The so-called dissociation curve shows the correlation between pH value and the proportion of hypochlorous acid HOCl among all free chlorine. At a pH of 6.5, ca. 95 % of the free chlorine is present as HOCl. At a pH of 7.8, however, that number is only 30 %.

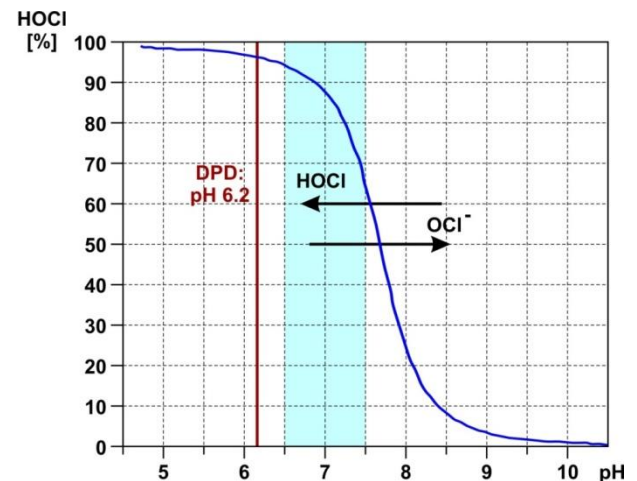

If control measurements are performed using the DPD method, then it is important to know that the DPD measurement is always performed at a pH value of ca. 6.2. That value is attained with an integrated pH buffer in the DPD reagents. Thus, a DPD measurement always measures all free chlorine independently of the actual pH value in the pool. Therefore, a DPD measurement may not be significant for the real disinfection effectiveness, especially, if pH is above ca. 7.5.



#### HAZARD!

Overdosing if pH value is wrong

If disinfection is enabled before the pH value is stable in the ideal range of 7.0 to 7.4, then it may lead to heavy overdosing of chlorine or bromine.

**Potential consequence: Death or the gravest degree of injury, heavy material damage.**

- Do not start disinfection with chlorine or bromine until the pH value is stable in the ideal range between 7.0 and 7.4.

**11.2.4 Active oxygen (Bayrosoft® Light)**



**INFO**

This section applies for the model PoolManager® O2 only.

For disinfection with active oxygen, a main dosage is performed automatically once a week in order to initially raise the pool's oxygen content to a high level, thereby yielding a strong disinfection effect. Then additional intermediate dosages are performed throughout the course of a week as needed in order to maintain the oxygen level continuously over the required minimum value that ensures safe and reliable disinfection.

The volumes for the main dosage and the intermediate dosages are automatically adjusted to the average pool temperature in order to compensate for heavier product attrition at higher temperatures. This function is called temperature compensation.

**12 Measurement, control, dosing (pH value, redox value, chlorine / bromine)**



**INFO**

The information in this section on measuring and controlling the redox value applies only for the models PoolManager® Cl and PoolManager® Br.



The information on measuring and controlling the pH value applies for all PoolManager® models, i.e., also for PoolManager® O2.



**IMPORTANT NOTICE!**

**Need for calibration**

Correct calibration of pH measurement and, if applicable, redox measurement is an absolute requirement for exact and reliable measurement and control.

Please refer to the information in the section *Calibration*.

**12.1 Function**

Measurement and control for the pH value, free chlorine / bromine, and for the redox value are set-up as identically as possible.

PoolManager® continuously measures the pH value and the current redox value in the pool and compares the current measured values with the desired levels, which are configured as setpoints.

PoolManager® PRO continuously measures the pH value and the concentration of free chlorine / bromine in the pool and compares the current measured values with the desired levels, which are configured as setpoints.

If there is a deviation between the current measured value and the setpoint, a so-called control deviation, then PoolManager® activates the corresponding dosing pump (or other dosing equipment) in order to adjust quickly and precisely.

**12.2 Dosing rate**

The controller continuously calculates the optimal dosing rate in the current situation. The further the current measured value is from the setpoint, the higher the calculated dosing rate is.

Dosing rate is indicated as a percentage value [%]. A dosing rate of 100% means that the dosing pump is running continuously. The absolute dosing rate in l/h depends on the pump type used and / or the dosing hose used.

For lower dosing rates, the controller periodically turns the dosing pump on and off within a predefined dosing cycle (e.g., 60 s). For example, a dosing rate of 10% means that the dosing pump runs 10 % of the available time within a dosing cycle and stands still during 90 % of the time.

**Example:**

- The dosing cycle is set to 60 s.
  - The current dosing rate is 10 %.
- ⇒ The pumps running time will then be 10 % of 60s, i.e., 6s.
- ⇒ The pumps off time will then be 90 % of 60s, i.e., 54s.

The following figure shows cyclic turning on and off of dosing pumps for various dosing rates.

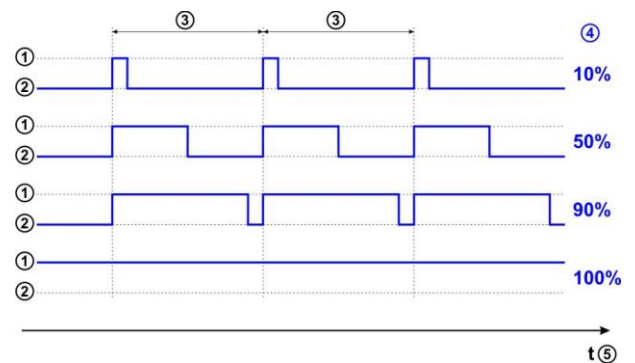

- Dosing pump running (on)
- Dosing pump not running (off)
- Dosing cycle (for example, 60s)
- Dosing rate 10 % / 50 % / 90 % / 100 %
- Time axis

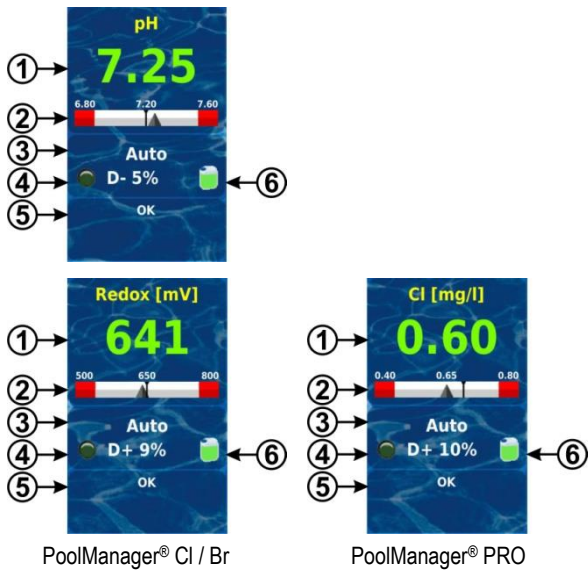

12.3 Show in home view



Pos.	Content	Notes
1	Current measured value	0.00...9.99 pH, 0...999 mV or 0.00...9.99 mg/l Colour of measured value display: <b>green</b> Normal operation, everything OK <b>'yellow</b> Dosage blocked (missing flow signal or start delay) <b>red</b> Alarm, dosage blocked!
2	Measured value scale	Graphic display of current measured value, setpoint, and alarm thresholds.
3	Current operating state	Auto / off / manual / alarm / flow / start delay (x min)
4a	LED symbol	The LED symbol illuminates when the corresponding dosing pump is running.
4b	Current dosing direction	D+ (increasing) / D- (reducing)
4c	Current dosing rate	0...100 % (dosing rate 50 % means, for example, that the dosing pump runs during 50 % of the time of each dosing cycle)
5	Alarms	All active alarms are shown regarding the current module. Alarms whose cause has already been resolved disappear from the display, even if they have not been acknowledged. If there is no active alarm, "OK" appears.
6	Canister symbol	Fill level for the respective canister (red / yellow / green)

12.4 Configuration parameters

You'll find all configuration parameters in the following menus:

-  Configuration pH
-  Configuration Redox (mV) (PoolManager® Cl / Br only)
-  Configuration Chlorine (PoolManager® PRO only)

Several of the configuration parameters are found in the sub-menu *Advanced Settings*.

12.4.1 Setpoint

The setpoint sets the desired optimum value of the controlled parameter. The control system always attempts to adjust the measured value to match the setpoint as quickly and precisely as possible.

12.4.2 Lower alarm threshold

If the measured value falls below the lower alarm threshold, the PoolManager® will report a lower measured value alarm.

12.4.3 Upper alarm threshold

If the measured value exceeds the upper alarm threshold, the PoolManager® will report an upper measured value alarm.

12.4.4 Proportional range

The control system works as a proportional control system, which means dosing output is increased in proportion with the control deviation, i.e., the deviation between the current measured value and the configured setpoint. The further the values in the pool deviate from the setpoint, the more maintenance product is dosed in order to reach the setpoint quickly and precisely.

The proportional range, abbreviated p-range, is the range in which the control system varies dosing output in proportion with the control deviation between 0 % (dosing pump off) and 100 % (dosing pump running permanently).

**Example 1 (pH):**

- Setpoint pH 7.20
- Proportional range 1.00 pH
- Dosing direction D- (pH reducing)
- ⇒ The proportional range begins with the setpoint (pH 7.20, dosing rate 0 %)
- ⇒ The proportional range ends at 1.00 pH above the setpoint, i.e., at pH 8.20 (dosing rate 100 %)
- ⇒ The centre of the proportional range is at pH 7.70 (dosing rate 50 %)

**Example 2 (redox):**

- Setpoint 750 mV
- Proportional range 200 mV
- Dosing direction D+ (increase of redox value)
- ⇒ The proportional range begins with the setpoint (750 mV, dosing rate 0 %)
- ⇒ The proportional range ends 200 mV below the setpoint, i.e., at 550 mV (dosing rate 100 %)
- ⇒ The centre of the proportional range is at 650 mV (dosing rate 50 %)



**Example 2 (chlorine, PoolManager® PRO only):**

- Setpoint 0.65 mg/l
- Proportional range 0.50 mg/l
- Dosing direction D+ (increase of chlorine value)
- ⇒ The proportional range begins with the setpoint (0.65mg/l, dosing rate 0 %)
- ⇒ The proportional range ends 0.50 mg/l below the setpoint, i.e., at 0.15 mg/l (dosing rate 100 %)
- ⇒ The centre of the proportional range is at 0.40 mg/l (dosing rate 50 %)

The following figure shows the correlation between the current measured value and the dosing rate for various configurations of the proportional range for pH (dosing direction D-).

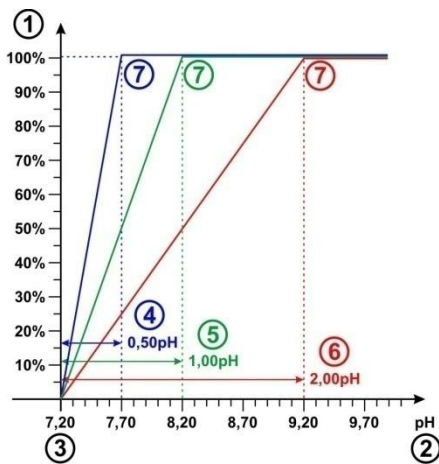

- 1 Dosing rate in %
- 2 Measured pH value
- 3 Configured setpoint pH 7.20
- 4 Proportional range 0.50 pH (pH 7.20 - 7.70)
- 5 Proportional range 1.00 pH (pH 7.20 - 8.20)
- 6 Proportional range 2.00 pH (pH 7.20 - 9.20)
- 7 At the end of the proportional range, the dosing rate reaches 100%, i.e., the dosing pump runs permanently.



**INFO**

**Basic rules for the proportional range**

The following basic rules are helpful for the proportional range:

**A larger proportional range will result in a lower dosing output.**

For example, doubling the proportional range will halve the dosing output.

**A smaller proportional range will result in a higher dosing output.**

For example, halving the proportional range will double the dosing output.



**INFO**

**Pool volume and dosing rate**

The default values for the proportional range are orientated towards the following general conditions.

- Assuming a pool volume of ca. 40 m<sup>3</sup>
- dosing pump output ca. 1.5 l/h

**For pool volumes that are larger in relation to the dosing pump output, the proportional range generally has to be reduced.**

This leads to longer switch-on times on the dosing pump, and therefore to higher dosage overall.

**For smaller pool volumes in relation to the dosing pump output, the proportional range generally has to be increased.**

This leads to shorter switch-on times on the dosing pump, and therefore to lower dosage overall.



**INFO**

**Influence on the control system**

In the following cases, the proportional range should be reduced, thereby increasing the dosing output:

- If the control system reacts slowly, and the setpoint is not approached or is only approached slowly

In the following cases, the proportional range should be increased, thereby decreasing the dosing output:

- If the control system reacts too quickly or unstably

**12.4.5 Minimum dosing rate**

A purely proportional control system generally has problems in actually reaching the desired setpoint. When approaching the setpoint, the dosing rate drops continuously and approaches 0 %.

In order to guarantee the setpoint is reached, a minimum dosing rate is configured that is maintained until the setpoint is actually reached.

The following figure uses the pH control system as an example to show the progress of the actual dosing rate with a minimum dosing rate of 5%.

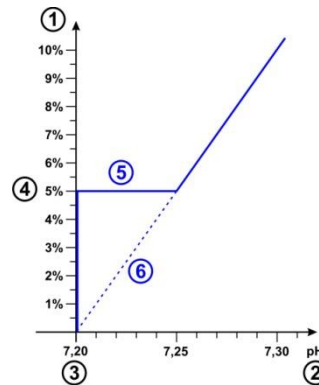

- 1 dosing rate in %
- 2 Measured pH value
- 3 Configured setpoint pH 7.20
- 4 Configured minimum dosing rate (5 %)
- 5 Constant dosing at the minimum dosing rate upon approaching the setpoint
- 6 Theoretical progress without a minimum dosing rate



**INFO**

**Dosing when near the setpoint**

The dosing rate when near the setpoint, i.e., for small control deviations, is determined by the configured minimum dosing rate only. The proportional range has no influence when near the setpoint.



**INFO**

**Pool volume and dosing rate**

The default values for the minimum dosing rate are oriented towards the following general conditions:

- Assuming a pool volume ca. 40 m<sup>3</sup>
- dosing pump output ca. 1.5 l/h

For larger pool volumes in relation to the dosing pump output, the minimum dosing rate generally has to be increased.

For smaller pool volumes in relation to dosing pump output, the minimum dosing rate generally has to be reduced.



**INFO**

**Effect of the minimum dosing rate**

The minimum dosing rate should be increased in the following cases:

- When the setpoint is not reached, or reached only very slowly

The minimum dosing rate should be decreased in the following cases:

- When the control system exceeds the setpoint, i.e., overdosage

**12.4.6 Intelligent dosing monitoring**

If the current measured value deviates from the desired setpoint, then PoolManager® will dose maintenance product into the pool water in order to offset the deviation. In this case, it should be expected that the measured value approaches the setpoint.

PoolManager® checks in predefined intervals whether the setpoint is actually approached as expected. To do so, PoolManager® checks various criteria based on several conditions. If those criteria for approaching the setpoint are met, then dosing will be continued.

If those criteria are not met, then PoolManager® will report a dosing alarm and block dosing. In this case, there is presumably either a problem or the current settings are not appropriate for the pool. In the event of a dosing alarm, the entire system should be inspected for potential problems.

The dosing alarm and the dosing block are ended by pressing the corresponding button to acknowledge the dosing alarm in the alarm overview.

You can set the interval for dosing monitoring in [min] in the menu. At the end of each interval, a test is executed on whether the setpoint is being approached according to the criteria.



**INFO**

**Configuring dosing monitoring**

For most applications, the default setting for the dosing monitoring interval should deliver good results.

You should only increase the preconfigured interval if unjustified dosing alarms are repeatedly reported. In general, this will only happen if the pool is reacting extremely slowly, or if there is some other problem.

In this case, the entire installation should be checked, especially circulation in the pool.

**12.4.7 Deadzone**

An activated deadzone ensures that dosage is not started for very small deviations from the setpoint, but rather only after the current measured value departs from the deadzone. The deadzone is a tolerance range around the setpoint.

The following figure shows how the control system performs in the deadzone using pH control as an example.

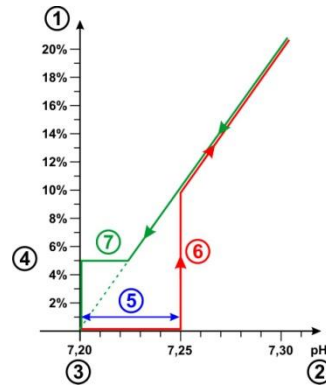

- 1 Dosing rate in %
- 2 Measured pH value
- 3 Configured setpoint pH 7.20
- 4 Minimum dosing rate (5%)
- 5 Deadzone (0.05pH ⇔ pH 7.20...7.25)
- 6 Dosage does not begin until the measured value departs from the deadzone
- 7 When approaching the setpoint, dosing will not stop when entering the deadzone but rather upon reaching the setpoint.



**INFO**

**Usage of the dead zone**

The standard setting for the dead zone is 0, i.e., the dead zone is not active.

It is particularly recommended to activate the dead zone for bi-directional pH control in order to avoid constant alternating triggering of the pH-Minus and pH-Plus dosing pumps.

**12.4.8 Dosing cycle**

The dosing cycle is a defined, fixed time interval in which the dosing pumps are turned on and off depending on the current dosing rate. The sum of switch-on duration and switch-off duration is always constant and equates to the dosing cycle.

A graphic presentation of the dosing cycle can be found in the section *dosing rate* above.



**INFO**

**Notes on configuring the dosing cycle**

For most applications, the standard setting for the dosing cycle should deliver good results.

For very small pools, such as whirlpools, a shorter dosing cycle may deliver better results under certain circumstances as the control system can react to changes more quickly.

**12.4.9 Dosing direction**

As already described in the *Water maintenance* section, the pH control system can be run in a pH-reducing, pH-elevating, or bi-directional manner depending on water composition.

The following image shows an example for control system output in the event of bi-directional dosing.

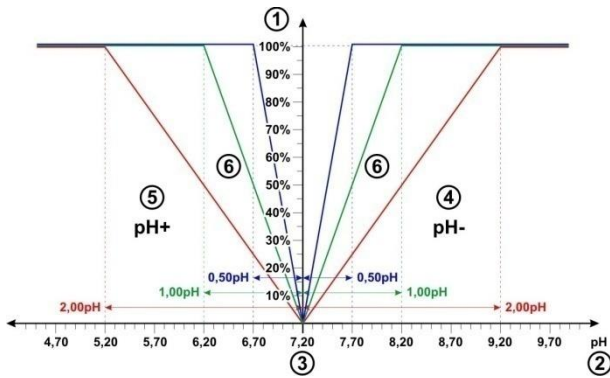

- 1 Dosing rate in %
- 2 Measured pH value
- 3 Configured setpoint pH 7.20
- 4 pH measured value is higher than setpoint ⇒ pH-Minus dosing
- 5 pH measured value is lower than setpoint ⇒ pH-Plus dosing
- 6 Dosing output for various proportional ranges

### 12.4.10 Recommended settings (PoolManager® CI / Br / O2)

The following table provides information on the recommended parameter settings for pH and redox control.

Recommended parameter settings		
Parameter	pH	Redox (mV)
Setpoint	Ideal range pH 7.0 ... 7.4	The right redox setpoint has to be determined individually for each pool; please refer to the section <i>Determining the redox (mV) setpoint</i>
Lower alarm threshold	approx. setpoint - 0.4 pH	approx. setpoint - 50 mV
Upper alarm threshold	approx. setpoint + 0.4 pH	approx. setpoint + 50 mV
Proportional range	approx. 1.50 pH for 40 m³ pool and dosing pumps 1.5 l/h, see section <i>Proportional range</i>	approx. 150 mV for 40 m³ pool and dosing pumps 1.5 l/h, see section <i>Proportional range</i>
Minimum dosing rate	approx. 4.0 % for 40 m³ pool and dosing pumps 1.5 l/h, see section <i>Minimum dosing rate</i>	approx. 4.0 % for 40 m³ pool and dosing pumps 1.5 l/h, see section <i>Minimum dosing rate</i>
Intelligent dosing monitoring	The standard setting (60 min) delivers good results in most applications and should only be changed in exceptional cases; see section <i>Intelligent dosing monitoring</i>	
Deadzone	0.00 pH for mono-directional control, 0.10 pH for bi-directional control	0mV
Dosing cycle	The standard setting (60s) delivers good results in most applications. For very small pools, e.g. whirlpools, it may be sensible to reduce to 30s.	
Dosing direction	Depending on water composition: D- (pH-reducing), D+ (pH-increasing) or bi-directional (D+/D-)	D+ (Increase in redox value by dosing chlorine or bromine)

### 12.4.11 Recommended settings (PoolManager® PRO)

The following table provides information on the recommended parameter settings for pH and chlorine / bromine control.

Recommended parameter settings		
Parameter	pH	Chlorine (Cl) / Bromine (Br)
Setpoint	Ideal range pH 7.0 ... 7.4	Depending on application region
Lower alarm threshold	approx. setpoint - 0.4 pH	approx. setpoint - 0.25 mg/l
Upper alarm threshold	approx. setpoint + 0.4 pH	approx. setpoint + 0.25 mg/l
Proportional range	approx. 1.50 pH for 40 m³ pool and dosing pumps 1.5 l/h, see section <i>Proportional range</i>	approx. = 50 mg/l for 40 m³ pool and dosing pumps 1.5 l/h, see section <i>Proportional range</i>
Minimum dosing rate	approx. 4.0 % for 40 m³ pool and dosing pumps 1.5 l/h, see section <i>Minimum dosing rate</i>	approx. 4.0 % for 40 m³ pool and dosing pumps 1.5 l/h, see section <i>Minimum dosing rate</i>
Intelligent dosing monitoring	The standard setting (60 min) delivers good results in most applications and should only be changed in exceptional cases; see section <i>Intelligent dosing monitoring</i>	
Deadzone	0.00 pH for mono-directional control, 0.10 pH for bi-directional control	0 mg/l
Dosing cycle	The standard setting (60s) delivers good results in most applications. For very small pools, e.g., whirlpools, it may be sensible to reduce to 30s.	
Dosing direction	Depending on water composition: D- (pH-reducing), D+ (pH-increasing) or bi-directional (D+/D-)	D+ (Increase in chlorine / bromine concentration)

## 12.5 Configuration Wizard

### 12.5.1 Basics

Sensible configuration of the proportional range and the minimum dosing output is largely dependent upon pool volume and dosing pump output. In the end, what counts is the ratio between pool volume and the pumps' dosing output.

The values used as the basis for the default settings are:

- Assuming a typical pool volume of 40 m³
- standard dosing pump output 1.5 l/h
- The assumed ratio between pool volume in [m³] and dosing output in [l/h] is therefore 40 to 1.5, i.e., approx. 27.

For a larger pool volume in relation to the dosing pump output, the control parameters generally have to be adjusted as follows:

- Smaller proportional range (⇒ higher dosing output)
- Higher minimum dosing output

Accordingly, for a smaller pool volume in relation to the dosing pump output the control parameters generally have to be adjusted as follows:

- Larger proportional range (⇒ lower dosing output)
- Lower minimum dosing output

### 12.5.2 Configuration Wizard

There is a configuration wizard in each of the configuration menus for pH and chlorine (Cl) and redox (mV). You only need to enter the pool volume and the dosing pump output [l/h] into the wizard. The wizard uses that data to calculate sensible basic settings for the control parameters, especially for the proportional range and the minimum dosing rate.

A manual adjustment may be entered in order to optimize the automatic calculation performed by the assistant:

Manual adjustment	Effect
0 %	Standard calculation, no correction
-90 %...-1 %	Reduction of the standard dosing rate by the indicated %-value for low use pools with low needs for maintenance products.
1 % ... 100 %	Increase of the standard dosing rate by the indicated %-value for high use pools with high needs for maintenance products.



#### IMPORTANT NOTICE!

##### Manual optimisation of control parameters

The control settings calculated with the help of the configuration wizard generally deliver good results but cannot guarantee optimum control quality in every case.

Under certain circumstances, it may be necessary to optimise the control parameters manually if problems arise.

## 13 Calibration (basic measurement adjustment)

A basic requirement for exact and reliable measurement and control is regular calibration of the measurement electrodes.

The electrodes convert the measured water parameters into an electric measurement signal. The correlation between the value in the pool and the electric measurement signal is not always the same and may vary from electrode to electrode. Also, it depends on water quality and other conditions that can change over the course of time.

Calibration calculates the exact correlation between the measured water parameter and the electric measurement signal. Precise measurement can only be expected after calibration.

### 13.1 When is calibration necessary?

Calibration absolutely must be performed in the following situations:

- First commissioning or recommissioning
- Water change
- Electrode replacement
- If there are relevant deviations between what the controller displays and the manual control measurements performed on a regular basis
- After adding other water treatment products or after miscellaneous changes in water quality
- In regular intervals, at least once a month



#### HAZARD!

##### Overdosing due to missing or incorrect calibration

Erroneous calibration, or not performing calculation, can lead to significant measurement errors, which under certain circumstances may result in heavy overdosing of pH-Minus or chlorine.

##### Potential consequence: Gravest degree of injury, heavy material damage.

- Perform careful calibration in each of the situations listed above

## 13.2 Calibration pH

There are various options for calibrating a pH electrode:

- 1-point calibration with buffer solution pH 7
- 2-point calibration with buffer solutions pH 7 and pH 9 (or other pairs)
- 1-point calibration to the pool's pH value (determined with photometer or colour tester using Phenol Red)

For 1-point calibration, the display value is moved up or down by an offset. The electrode slope is not recalculated in 1-point calibration. It remains unchanged.

In 2-point calibration, the electrode slope is recalculated in addition to the offset.



#### TIP

##### Calibration pH

Precise calibration can be attained with the following procedure:

##### Basic calibration step 1

2-point calibration with buffer solutions pH 7 and pH 9 in order to calculate the exact electrode slope.

##### Basic calibration step 2

Subsequent 1-point calibration to the pool's pH value with a photometer in order to attain the best concordance possible between the controller's display and the photometer measurement.

This calibration should be performed as close to the setpoint as possible, i.e., the pH value in the pool should be in the ideal range between 7.0 and 7.4

If there is no photometer available, then only step 1 should be performed. A simple colour tester does not produce reliable calibration with the required precision.

##### Recalibration

1-point calibration generally suffices for regular recalibration (at least once a month). If there is a photometer available, then recalibration should be performed to the pool's pH value; otherwise with buffer solution pH 7.

### 13.2.1 Calibration procedure

pH calibration can be found in the following menu:



Calibration pH

Calibration is carried out as follows:

- Select 1-point calibration pH or 2-point calibration pH
- Calibration is a menu sequence, i.e., it goes through a series of menus step-by-step.

#### 13.2.1.1 Calibration Data (1st and 2nd calibration point)

In the input menus for the 1st and 2nd calibration point, the following parameters are displayed:

##### Calibration value

For the calibration value, enter the reference value to which calibration should be performed.

When calibrating with a buffer solution, this will be the known pH value of the buffer solution, such as pH 7 or pH 9.

When calibrating to the pool water's pH value, this will be the value measured with a photometer (a simple colour tester is not suitable for calibration as the measurement precision is not sufficient).

##### Current Value

This is the current measured value calculated using the parameters from the last calibration, which are still valid. This value may deviate



from the actual value. It is only displayed to give you a certain level of orientation throughout calibration.

Using the measured value, you can see when measurement stabilises when you, for example, place the electrode into the buffer solution.

#### Current Signal

This is the currently measured electric signal on the electrode in [mV]. You can also use the measurement signal to see when measurement has stabilised.

Furthermore, you can use it to check the measurement signal for plausibility.

pH value	6.0	6.5	7.0	7.5	8.0	8.5
Typical measurement signal	+60 mV	+30 mV	0 mV	-30 mV	-60 mV	-90 mV

Tolerance to be expected  $\pm 10\%$

#### Electrode (for 1-point calibration only)

For 1-point calibration, the electrode slope is also displayed in [mV/pH] and can be edited manually. This makes it possible for you to enter a typical value for slope, or to reset slope to its default value.

For 2-point calibration, slope cannot be entered manually as it is calculated exactly during calibration.

#### 13.2.1.2 Calibration results

At the end of calibration, the calibration parameters calculated are displayed:

##### Electrode slope

For 2-point calibration, this is the newly calculated electrode slope in [mV/pH]; for 1-point calibration this is the previously entered value.

##### Offset

Offset is the zero-point shift calculated by calibration. Indicated in [pH].

##### Current value

The pH measured value is now calculated using the parameters from the current calibration. The measured value displayed should therefore be consistent with the calibration value entered.

#### 13.2.1.3 Step by step

##### 1-point calibration with buffer solution (e.g. pH 7)

1. Block the measuring water
2. Separate the electrode cable from the controller
3. Unscrew the pH electrode from the measurement chamber
4. Rinse the pH electrode off with (distilled) water
5. Carefully dab the pH electrode dry using a cloth (free from grease and fluff).
6. Connect the electrode cable to the controller again.
7. In the menu, select the function *1-point calibration pH*
8. Enter the pH value of the buffer solution as the *calibration value* (typically pH 7)
9. If necessary, enter a value for electrode slope or reset the value to default
10. Dip the pH electrode into the buffer solution (e.g., pH 7) and stir it carefully and briefly
11. If the displayed measured value and the measurement signal have stabilised and are no longer changing in a relevant manner, then confirm calibration by pressing *Next*.
12. Check the calibration results displayed and close calibration by pressing *Ready*.
13. Place the pH electrode back into the measurement chamber
14. Open the shut-off valves for measuring water

##### 2-point calibration with buffer solution (e.g., pH 9 and pH 7)

1. Block the measuring water
2. Separate the electrode cable from the controller
3. Unscrew the pH electrode from the measurement chamber
4. Rinse the pH electrode off with (distilled) water
5. Carefully dab the pH electrode dry using a cloth (free from grease and fluff).
6. Connect the electrode cable to the controller again.
7. In the menu, select the function *2-point calibration pH*
8. Enter the pH value of the 1st buffer solution as the *1st calibration value* (pH 9)
9. Dip the pH electrode into the 1st buffer solution (pH 9) and stir carefully and briefly
10. If the measured value displayed and the measurement signal have stabilized and are no longer changing in a relevant manner, then confirm the 1st calibration point by pressing *Next*.
11. Remove the pH electrode from the 1st buffer solution
12. Rinse the pH electrode off with (distilled) water
13. Carefully dab the pH electrode dry using a cloth (free from grease and fluff).
14. Enter the pH value of the 2nd buffer solution as the *2nd calibration value* (pH 7)
15. Dip the pH electrode into the 2nd buffer solution (pH 7) and stir carefully
16. If the measured value displayed and the measurement signal have stabilised and are no longer changing in a relevant manner, then confirm the 2nd calibration point by pressing *Next*.
17. Check the calibration results displayed and close calibration by pressing *Ready*.
18. Place the pH electrode back into the measurement chamber
19. Open the shut-off valves for the measuring water

##### 1-point calibration to the pool water's pH value

1. Take a water sample from the measurement chamber and measure the pH value using a photometer (phenol red method).
2. In the menu, select the function *1-point calibration pH*
3. Enter the pool water's pH value measured using the photometer as the *calibration value*
4. If necessary, enter a value for electrode slope or reset the value to default
5. If the measured value displayed and the *Current Signal pH* are stable and are no longer changing in a relevant manner, then confirm calibration by pressing *Next*.
6. Check the calibration results displayed and close calibration by pressing *Ready*.

#### 13.2.2 Calibration errors

During calibration, various plausibility criteria are checked. If one of the criteria is not met, then a corresponding error message appears, and calibration is not executed.

The following criteria have to be met for successful calibration:

The offset calculated (zero-point shift) has to be in the range of  $\pm 1.00$  pH. The offset is generally close to 0 for flawless electrodes.

The electrode slope calculated must be in the range of 50.0 mV/pH to 70.0 mV/pH. For flawless electrodes, the slope is generally between 55.0 mV/pH and 60.0 mV/pH.

For 2-point calibration, the two calibration values have to be at least 0.50 pH apart. 2-point calibration with buffer solutions pH 7 and pH 6.80, for example, is not possible.

#### 13.3 Calibration chlorine (Cl) / bromine (Br)



**INFO**  
PoolManager® PRO only

Calibration for free chlorine / bromine measurement is performed as 1-point calibration. The pool water's DPD measured value is entered as reference value. It can be measured using a photometer. Alternatively, a simple colour test can be used. However, this is not recommended due to the limited precision.



**IMPORTANT NOTICE!**

**Calibration near to setpoint**

For reliable and precise calibration of chlorine / bromine measurement, this has to be performed as close to the desired setpoint as possible.

- First bring the chlorine / bromine concentration in the pool to the desired level (=setpoint) via manual dosing or manual addition.
- Check the value via DPD measurement
- Do not perform calibration until the value in the pool is close to the desired setpoint (recommended tolerance approx. setpoint  $\pm 10\%$ )



**IMPORTANT NOTICE!**

**Calibration for bromine**

Bromine concentration and chlorine concentration can be calculated using DPD measurement. However, the same colour on the DPD sample means different values for chlorine and bromine.

- If your photometer / colour tester explicitly supports bromine measurement, then you can use the bromine value read directly.
- If your photometer / colour tester only supports chlorine measurement, then you have to multiply the chlorine value by 2.2 in order to obtain the correct bromine value (e.g., DPD measurement for chlorine displays 1.0 mg/l  $\Rightarrow$  bromine 2.2 mg/l).



**INFO**

**Internal 2-point calibration**

Even if you only have to enter one calibration point, Analyt internally performs a precise 2-point calibration. The second calibration point used is the zero point from the potentiostatic measurement, which is always nearly constant.

**13.3.1 Calibration procedure**

Chlorine / bromine calibration can be found in the following menu:



Calibration Cl (Br)

Calibration is carried out as follows:

- Select *Calibration Cl*
- Calibration is a menu sequence, i.e., it goes through a series of menus step-by-step.

**13.3.1.1 Calibration Data**

The following parameters are displayed in the Calibration menu:

**Calibration value**

Enter the measured DPD value as the calibration value (calibrate close to setpoint!).

**Current value**

This is the current measured value calculated using the parameters from the last calibration, which are still valid. This value may deviate from the actual value. It is only displayed to give you a certain level of orientation throughout calibration.

Using the measured value, you can see whether measurement is sufficiently stable for reliable calibration.

**13.3.1.2 Calibration results**

At the end of calibration, the calibration parameters calculated are displayed:

**Offset**

Offset is the zero-point shift calculated from calibration. It is indicated in [mg/l].

**Current value**

The chlorine / bromine measured value is now calculated using the parameters from the current calibration. The measured value displayed should therefore be consistent with the calibration value entered.

**13.3.1.3 Step by step**

**Calibration to the measured DPD value**

1. Take a water sample from the measurement chamber and calculate the chlorine / bromine value using a photometer (DPD1 method).
2. In the menu, select the function *Calibration Cl*
3. Enter the pool water's DPD value calculated as the *calibration value*
4. If the measured value displayed and the *Current Signal* are stable and are no longer changing in a relevant manner, then confirm calibration by pressing *Next*.
5. Check the calibration results displayed and close calibration by pressing *Ready*.

**13.3.2 Calibration errors**

During calibration, various plausibility criteria are checked. If one of the criteria is not met, then a corresponding error message appears, and calibration is not executed.

The following criteria have to be met for successful calibration:

- Calibration must be performed for a calibration value (DPD value) of at least 0.20 mg/l.
- The offset calculated (zero-point shift) has to be in the range of  $\pm 1.00$  mg/l. The offset is generally close to 0 for flawless electrodes.
- The slope calculated has to be in the range of 1  $\mu$ A/mg/l – 250  $\mu$ A/mg/l. For flawless electrodes, slope is generally in the range of 5  $\mu$ A/mg/l – 20  $\mu$ A/mg/l.

### 13.4 Calibration redox (mV)

The calibration for redox measurement is performed as 1-point calibration. A buffer solution with a known redox value (e.g., 465 mV) is used.



#### TIP

#### Redox calibration

Depending on water quality and the state of the electrode, it can occur that the redox electrode reacts very slowly if it is moved from the buffer solution back into the measuring water after calibration. In disadvantageous conditions, it may take several hours until the measured redox value stabilises again and is displayed correctly.

During that time, reasonable configuration and activation of redox control is not possible.

Therefore, it is recommended to only perform redox calibration when necessary, such as when it is suspected that the electrode could be defective.

Calibration can be omitted for the following reasons in order to avoid potential problems with running-in time:

Functioning redox electrodes generally have a tight tolerance range, such that calibration only changes the display value by a few mV.

The absolute redox value is not of significant. Assigning the redox value to the chlorine value in the pool is more important; see section *Determining the redox (mV) setpoint*.

#### 13.4.1 Calibration procedure

Redox (mV) calibration can be found in the following menu:



#### Calibration Redox (mV)

Calibration is carried out as follows:

- Select 1-point Calibration Redox (mV)
- Calibration is a menu sequence, i.e., it goes through a series of menus step-by-step.

##### 13.4.1.1 Calibration Data

The following parameters are displayed in the calibration menu:

#### Calibration value

For calibration value, enter the reference value for calibration, i.e., the redox value of the buffer solution being used (e.g., 465 mV).

#### Current value

This is the current measured value calculated using the parameters from the last calibration, which are still valid. This value may deviate from the actual value. It is only displayed to give you a certain level of orientation throughout calibration.

Using the measured value, you can see when measurement has stabilised when you place the electrode into the buffer solution.

##### 13.4.1.2 Calibration results

At the end of calibration, the calibration parameters calculated are displayed:

#### Offset

Offset is the zero-point shift calculated from calibration. It is indicated in [mV].

#### Current value

The redox (mV) measured value is now calculated using the parameters from the current calibration. The measured value displayed should therefore be consistent with the calibration value entered.

#### 13.4.1.3 Step by step

##### 1-point calibration with buffer solution (e.g. 465 mV)

1. Block the measuring water
2. Separate the electrode cable from the controller
3. Unscrew the redox electrode from the measurement chamber
4. Rinse the redox electrode off with (distilled) water
5. Carefully dab the redox electrode dry using a cloth (free from grease and fluff)
6. Connect the electrode cable to the controller again.
7. In the menu, select the function *1-point Calibration Redox (mV)*
8. Enter the buffer solution's redox value as the *calibration value* (e.g., 465 mV)
9. Dip the redox electrode into the buffer solution (e.g., 465 mV) and stir it carefully and briefly.
10. If the measured value displayed has stabilised and is no longer changing in a relevant manner, then confirm calibration by pressing *Next*.
11. Check the calibration results displayed and close calibration by pressing *Ready*.
12. Place the redox electrode back into the measurement chamber
13. Open the shut-off valves for the measuring water

#### 13.4.2 Calibration errors

During calibration, various plausibility criteria are checked. If one of the criteria is not met, then a corresponding error message appears, and calibration is not executed.

The following criteria have to be met for successful calibration:

- The offset calculated (zero-point shift) has to be in the range of  $\pm 100$  mV. The offset is generally close to 0 for flawless electrodes.

#### 13.5 Determining the redox (mV) setpoint

Electrode calibration is not of decisive importance for redox control. Correct determination of the redox setpoint is.

After all, redox control should provide the desired level of chlorine / bromine in the pool. As long as water quality and other general conditions do not change significantly, the redox value measured is directly dependent upon the concentration of free chlorine / bromine. A change in chlorine / bromine concentration always results in a change in the redox potential measured. Conversely, this means that the chlorine / bromine concentration remains constant if the control system is providing a constant redox value. It counteracts a sinking redox value immediately by dosing chlorine / bromine, thereby maintaining a constant redox value at the configured setpoint.



#### IMPORTANT NOTICE!

##### Determining the correct redox setpoint

The redox value for the desired chlorine / bromine value can vary widely from pool to pool.

**Therefore, the correct redox setpoint must be determined individually for each pool.**

Values experienced in the past are surely helpful for orientation. However, the redox setpoint cannot be configured based solely on values experienced in the past, as the correct redox setpoint in an individual case can deviate significantly from values experienced in the past.

#### 13.5.1 Step by step

1. Bring the pool to the desired chlorine / bromine level via manual dosing or manual addition of chlorine or bromine. It's best to add

- the required volume in multiple increments and to check the value repeatedly using DPD measurements.
- After the desired chlorine or bromine value has been set in the pool and checked via DPD measurement, observe the redox value shown on the PoolManager®. It will rise due to the addition of chlorine or bromine.
  - Wait until the displayed value has stabilised. It should stop experiencing relevant changes within 10-15 minutes.
  - The redox value shown corresponds to the previously configured chlorine / bromine value in the pool. Thus, configure the redox value shown as the setpoint for redox control.
  - Redox control will then maintain the redox value at the configured setpoint, simultaneously providing for a constant chlorine / bromine value in the pool.



**IMPORTANT NOTICE!**

**Redox electrode stabilisation**

Depending on water quality and the state of the electrode, it can occur that the redox electrode reacts very slowly when reinserted or when moved from the buffer solution back into the measuring water after calibration. In disadvantageous conditions, it may take up to 24 hours for the measured redox value to stabilise and be displayed correctly.

The correct redox value cannot be read and applied as the setpoint until after stabilisation has occurred.

**Recommendations:**

Insert a new redox electrode into the measuring water circuit as early as possible. Then, it will be able to stabilise even if the final chlorine / bromine value is not yet configured.

Observe the redox value for at least 15 minutes. The redox value cannot be considered to be sufficiently stable until the change over that time frame is max. 1-2 mV.

Even if the value no longer changes within 15 minutes, under certain circumstances it may very slowly rise up to 20 or 30 mV over the next 24 hours. Therefore, check redox control again a few days after commissioning. Perform a DPD measurement and optimise the configured redox setpoint as needed.

**14 Automatic dosing O2 (Bayrosoft® Light)**



**INFO**

This section applies for the model PoolManager® O2 only.

**14.1 Basic concept**

Adding the optimal volume of Bayrosoft® Light into the swimming pool water is executed in multiple automatic dosings per week. The main dosing is performed on a specific chosen weekday, which provides for a high Bayrosoft® Light concentration and therefore for optimal disinfection. Then additional intermediate dosings are performed throughout the course of a week as needed in order to maintain the oxygen level continuously over the requisite minimum value that ensures safe and reliable disinfection.

The volumes for the main dosing and the intermediate dosings are automatically adjusted to the average pool temperature in order to compensate for heavier product attrition at higher temperatures. This function is called temperature compensation.

The recommended setting for the basic dosing amount is 1.5 litres per 10 m³ of pool volume.

**14.1.1 Main dosing**

The main dosing is performed on a specific weekday, the main dosing day. The volume of Bayrosoft® Light dosed on that day is based on the programmed basic dosing amount. However, depending on the water temperature measured, the actual dose amount may be increased by a certain factor. This mechanism is called temperature compensation. The dose amount is corrected such that the increasing product consumption that occurs with increasing temperature is compensated.

The factor used to increase the programmed dosing amount is given in the following table:

Factor	Average temperature value from the previous week									
	≤24°C	25°C	26°C	27°C	28°C	29°C	30°C	31°C	32°C	>32°C
	1.00	1.06	1.10	1.15	1.20	1.28	1.40	1.57	1.80	2.00

No temperature compensation is performed for water temperatures under 24 °C.

For water temperatures over 32 °C, double the programmed dosing amount is added.

**Example:**

Programmed basic dosing amount of 2.0 litres, water temperature at 28 °C:

Main dosing amount = 2.0 litres x factor of 1.20 = 2.40 litres

The main dosing is performed on the programmed dosing weekday at midnight.

If the flow signal is missing (e.g., due to circulation being turned off) or if there is an alarm, then main dosing will be delayed. It will be performed at the earliest possible point in time. A main dosing is discarded at the next main dosing day, if it could not be performed up until that point, e.g., due to continuous alarms.

**14.1.2 Refresh dosing**

Throughout the course of a week until the next main dosing, the volume of effective Bayrosoft® Light in the water diminishes. Product consumption increases with higher temperatures. To counteract this and to always guarantee the optimum volume of Bayrosoft® Light in the water, refresh dosings are performed after 1/3 and after 2/3 of the week (1/3 week = 56 hours = 2 days and 8 hours).

The refresh dosing amount depends on the following factors:

- Programmed basic dosing amount
- Average water temperature measured (for the prior 1/3 week)
- *Temperature compensation* setting (off / normal / high)

When temperature compensation is turned off, no refresh dosing is performed.

When temperature compensation is turned on, the refresh dosing amount is determined by multiplying the programmed basic dosing amount by a temperature-dependent factor:

	Average temperature value from the prior 1/3 week				
	≤ 24 °C	24-26 °C	26-28 °C	28-30 °C	> 30 °C
Factor for <i>normal</i> temperature compensation	0	0.1	0.2	0.3	0.4
Factor for <i>high</i> temperature compensation	0	0.2	0.4	0.6	0.8

For temperatures under 24 °C, refresh dosing is not performed (factor = 0)

**Example:**

Programmed basic dosing amount of 2.0 litres, water temperature at 28 °C, temperature compensation set to "normal"

- Refresh dosing amount = 2.0 litres x factor of 0.2 = 0.4 litres

If the temperature compensation setting is changed to "high":

- Refresh dosing amount = 2.0 litres x factor of 0.4 = 0.8 litres

The 1st refresh dosing is performed two days after the programmed dosing weekday at 8:00 a.m.

The 2nd refresh dosing is performed four days after the programmed dosing weekday at 4:00 p.m.

If there is no flow signal (e.g., due to circulation being turned off) or if there is an alarm, then the refresh dosing will be delayed. They will be performed at the earliest possible point in time.

A refresh dosing is discarded at the next main dosing day, if it could not be performed up until that point.

**Example:**

If the dosing day is set to "Friday," dosing times are as follows

- ⇒ Main dosing, Friday at midnight
- ⇒ 1st refresh dosing, Sunday at 8:00 a.m.
- ⇒ 2nd refresh dosing, Tuesday at 4:00 p.m.

**14.1.3 Progression of effective Bayrosoft® Light concentration**

The following two figures schematically show the progression of the effective Bayrosoft® Light concentration in the water over the course of a week.

In the first example, the average water temperature is 24 °C. Thus, the two refresh dosings are omitted.

In the second example, the water temperature is 28 °C. Therefore, the two refresh dosings provide an intermediate increase in the effective Bayrosoft® Light concentration in the water.

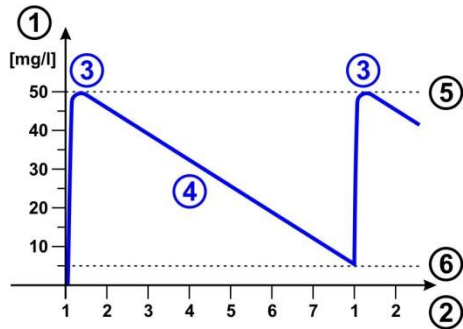

Automatic dosing at 24 °C (without intermediate refresh dosings)

- 1 Bayrosoft® Light concentration in the pool in [mg/l]
- 2 Weekdays (1 = main dosing day)
- 3 Main dosing
- 4 Reduced Bayrosoft® Light concentration due to product consumption
- 5 Bayrosoft® Light concentration after a main dosing (ca. 50 mg/l, "shock disinfection")
- 6 Required minimum concentration of Bayrosoft® Light (approx. 5 mg/l)

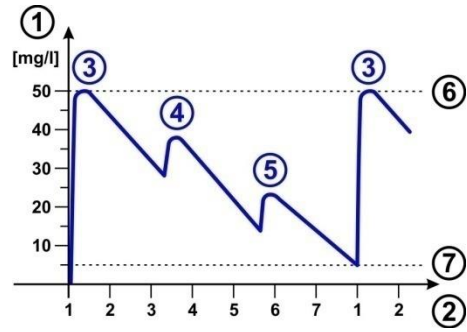

Automatic dosing at 28 °C (with two intermediate refresh dosings)

- 1 Bayrosoft® Light concentration in the pool in [mg/l]
- 2 Weekdays (1 = main dosing day)
- 3 Main dosing
- 4 1st refresh dosing after 1/3 week
- 5 2nd refresh dosing after 2/3 week
- 6 Bayrosoft® Light concentration after a main dosing (ca. 50 mg/l, "shock disinfection")
- 7 Required minimum concentration of Bayrosoft® Light (approx. 5 mg/l)



14.2 Show in Home view

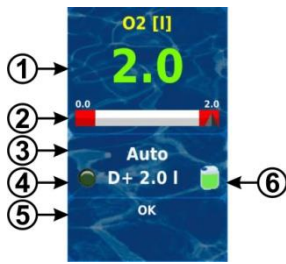

Pos.	Content	Notes
1	Programmed dosing amount (Basic dosing amount)	During ongoing dosing, the amount already dosed is displayed, i.e., the display rises continuously from 0.0 litres to the total dosing amount. After completing dosing, the display jumps back to the programmed dosing amount. Colour of the value display: <b>green</b> Normal operation, everything OK <b>yellow</b> Dosing blocked (missing flow signal or start delay) <b>red</b> Alarm, dosing blocked!
2	Value scale	The value scale graphically shows the amount already dosed during an ongoing dosing.
3	Current operating state	Auto / off / alarm / flow / start delay ("x min") / ongoing dosing (display of remaining time in minutes "x min")
4a	LED symbol	The LED symbol illuminates while the O2 (Bayrosoft® Light) dosing pump is running.
4b	Current dosing direction (or type of dosing)	D+ for automatic dosing and M for manual dosing (M = "manual")
4c	Current dosing amount (or programmed basic dosing amount)	While dosing is running, this shows the total amount of the current dosing (main dosing, refresh dosing, or manual dosing). After completing dosing, the display jumps back to the programmed dosing amount.
5	Alarms	All active alarms are shown regarding the O2 (Bayrosoft® Light) module. Alarms that are no longer active disappear from the display, even if they have not yet been acknowledged. If there is no active alarm, "OK" appears.
6	Canister symbol	Fill level for the Bayrosoft® Light canister (red / yellow / green)

14.3 Main Menu O2 (Bayrosoft® Light)

The menu  Main Menu O2 (Bayrosoft® Light) contains the following sub-menus.

**Configuration O2 (Bayrosoft® Light)**

Configuration of all relevant parameters for automatic O2 dosing

**Additional dosings**

In this menu, supplemental dosings can be configured; see section *Additional dosings*.

**Operating hours**

In this menu, the permissible times for Bayrosoft® Light dosing can be restricted. This can be used when, for example, if no dosing during night-time hours is preferred.

**Planned Dosings**

Display of the next planned main and refresh dosages. There is also an option to reschedule the planned dosings.

**Average Temperature**

Display of average temperature value measured for the entire week and for the individual 1/3 weeks

**Date & Time**

Here, correct configuration of the current weekday, date, and time can be checked and corrected as needed.

The menu  *Planned Dosings* (also accessible via the menu *O2 (Bayrosoft® Light)*) contains the following information:

- Display of the next planned dosings with date and time. The main dosing and the two refresh dosings are displayed.

When needed, dosing planning can be rescheduled in this menu.

In this case, the current plan is discarded and an entirely new plan is performed, starting from the current weekday and time.

Note: Additional dosings are NOT displayed.

14.4 Configuration O2 (Bayrosoft® Light)

The following settings can be configured:

Parameter	Setting range	Standard setting Default set Europe
Pool volume	1...5000 m³	40 m³
	When entering the pool volume, the Bayrosoft® Light dose amount is automatically adjusted to match the pool size (0.5 litre per 10 m³ of pool volume).	
Basic dosing amount	0.0...99.9 l	1.5 litre per 10 m³ of pool volume (e.g., 6.0 l for 40 m³ pool volume)
	Here, the basic dosing amount is indicated for automatic O2 dosing. The standard value based on the pool volume can be adjusted again. The actual main dosing amount and the two refresh dosings depend on the average water temperature measured.	
Temp. compensation	Off / normal / high	Normal
	Temperature compensation should be set to "high" if the Bayrosoft® Light refresh dosings prove to be too low.	
Pump config. O2	0.5 l/h / 0.9 l/h / ...	3 l/h
	 Here, the Bayrosoft® Light dosing pump capacity is entered. This setting absolutely must be set correctly for the pump used. Otherwise, PoolManager® will not correctly calculate the required pump runtime for a dosing, and Bayrosoft® Light dosing amounts won't be correct! The dosing capacity for the standard Bayrosoft® Light dosing pump is 3.0 l/h.	
Dosing day O2	Monday ... Sunday	Friday
	Weekday for the main dosing.	
6s dosing	Active / inactive	Active
	After turning on PoolManager® and also after every 12 hours of operation, the Bayrosoft® Light pump is briefly started for approx. 6s in order to hinder product deposits.	

### 14.5 Additional dosings

PoolManager® provides the option of programming additional dosings in addition to the automatic dosings with temperature compensation.

The additional dosing are then performed in supplement to the main dosing and to the refresh dosings. The additional dosing amount is a fixed, programmed figure and is not temperature compensated.

For additional dosings, the following parameters can be configured in the menu "Additional dosings":

Parameter	Explanation
Days of Week	Here the days of the week on which additional dosing is to take place (one or more) can be selected. Default: Off
Time	Start time of the additional dosing (the same for every weekday). Default: 00:00
Additional Dosing amount	Dosing amount for additional dosings (the same for every weekday). Default: 0.2 l

#### Example:

The system should be configured such that on Friday 2.5 l of Bayrosoft® Light is dosed and 2.0 l each on Monday and Wednesday. Temperature compensation is not desired.

To do so, the following settings are required:



Main Menu O2 (Bayrosoft® Light)

Sub-menu Configuration O2 (Bayrosoft® Light)

- Dosing amount O2 = 2.5 l
- Temp. compensation = Off
- Dosing day O2 = Friday
- Sub-menu *Additional dosings*:
- Weekdays = Monday, Wednesday
- Additional dose amount = 2.0 l

If temperature compensation is activated, the main dosing is compensated for temperature and, if applicable, the two refresh dosings are additionally performed.

## 15 Temperature measurement

### 15.1 Overview

PoolManager® has a total of three temperature measurement inputs. A temperature sensor can be connected to each of them. The three inputs are marked Temp.1 (T1), Temp.2 (T2), and Temp.3 (T3).

T1 and T2 cover a measuring range of 0 – 50°C, T3 covers 0 – 75°C.

The standard temperature sensor for the measuring water is connected to T1 in the factory configuration.

### 15.2 Measuring water temperature

PoolManager® measures the temperature of the measuring water flowing through the measurement chamber. For that purpose, a PT1000 temperature sensor is integrated into the measurement chamber and connected to the input Temp.1 (T1).

For PoolManager® O2, temperature measurement is used for calculating temperature compensation (see section Automatic O2 (Bayrosoft® Light) dosing).

### 15.3 Measured temperatures

Various functions and sensor types can be allocated to all three temperature inputs. Allocation is realised in the following menu:



Configuration Temperature

The following functions can be assigned to each individual temperature input in the *Temperature sensor configuration* sub-menu:

- **Sample water**  
Temperature of measuring water. The integrated standard measuring water sensor in the measurement chamber is connected to input Temp. 1 (T1) in the factory configuration.
- **Pool water**  
Temperature of the pool water (measurement in circulation circuit)
- **Solar temperature**  
Water temperature in the solar collector
- **Air (pool)**  
Air temperature in the indoor pool hall
- **Air (outdoor)**  
Outside air temperature

### 15.4 Sensor types

Furthermore, the sensor type used can be configured for each temperature input:

- **PT1000 (standard)**  
This is the standard measuring water temperature sensor used in the measurement chamber.
- **KTY83**  
This model was used in earlier BAYROL controllers
- **KTY16-6 (2 kΩ parallel)**  
This model is also common in the swimming pool industry



#### IMPORTANT NOTICE!

##### KTY16-6 temperature sensor

When using a KTY16-6 sensor, a **2 kΩ resistor** has to be connected parallel to it in order to match the sensor to the measurement range of the two other sensor models.

15.5 Show in the home view

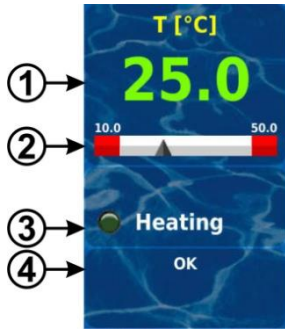

Pos.	Content	Notes
1	Current measured value	0.0...50.0 °C (input T3: 0.0...75.0 °C) Colour of measured value display: <b>green</b> Normal operation, everything OK <b>yellow</b> Flow signal missing or start delay <b>red</b> Alarm
2	Measured value scale	Graphic display of current measured value and alarm thresholds.
3a	LED symbol	The LED symbol is only displayed when the add-on <i>heating</i> or <i>solar heating</i> functions are being used. It illuminates when the heating system is currently heating.
3b	Status of heating and/or solar heating	This status is only displayed when the add-on <i>heating</i> or <i>solar heating</i> functions are being used. For details, please review the sections <i>Heating</i> or <i>Solar Heating</i> .
4	Alarms	All active alarms are shown regarding temperature measurement. Alarms that are no longer active disappear from the display, even if they have not yet been acknowledged. If there is no active alarm, "OK" appears.

15.6 Configuration temperature

Configuration of temperature measurement is performed in the menu:



Configuration Temperature

There, the following parameters can be configured:

Parameter	Setting range	Standard setting, default set Europe
Input for temperature display	The input used for the main temperature display on the controller can be selected. Standard is Temp. input 1 [3]	
Sub-menu <i>Alarm limits</i>		
Lower alarm threshold T1 / T2 / T3	0.0...50.0 °C (T3 0.0...75.0 °C)	10.0 °C
Upper alarm threshold T1 / T2 / T3	0.0...50.0 °C (T3 0.0...75.0 °C)	50.0 °C
Sub-menu <i>Temperature sensor configuration</i>	Configuration of functions and sensor types for T1 / T2 / T3	

15.7 Calibration

Calibration of temperature measurement is performed in the menu:



Calibration Temperature

Please perform calibration as follows:

1. Select the temperature input to be calibrated  
*1-Point Calibration T1 / T2 / T3*
2. Measure the corresponding temperature (water, solar, air) for the corresponding input on the thermometer
3. Enter the temperature measured as the calibration value
4. If the displayed measured value (Current value) is stable and is no longer changing in a relevant manner, then confirm calibration by pressing *Next*.
5. Check the calibration results displayed and close calibration by pressing *Ready*.

16 Manual dosing

16.1 Overview

For each module pH, chlorine (Cl) / bromine (Br), redox (mV), and O2, there is the option of adding product to the swimming pool water via manual dosing.

Manual dosing is restricted in time and will automatically end after the selected dosing duration has passed. Furthermore, manual dosing can be manually stopped at any time. During manual dosing, the dosing pump runs continuously, i.e., at a dosing rate of 100 %.

Manual dosing can be blocked by alarms; see section *blocking via alarms*.

16.2 Menu manual dosing

Manual dosing can be started in the following menus (depending on the controller model):



Manual Dosing pH



Manual Dosing Chlorine /Bromine



Manual Dosing mV (Chlorine) / Manual Dosing mV (Bromine)



Manual Dosing O2



The following displays and settings are available in each menu:

Parameter	Setting range	Standard setting Default set Europe
Current Value pH / mV / Cl / Br	Display of current measured value for orientation	
Manual Dosing Direction	D- / D+	pH: D- mV / Cl / Br: D+
	Dosing direction in manual dosing can only be selected for pH if pH control is working bi-directionally.	
Pump Config. pH / mV / O2	0.5 l/h / 0.9 l/h / ...	pH / Cl / mV: 1.5 l/h O2: 3 l/h
	 Here, the dosing pump capacity is entered. This setting absolutely must be set correctly for the pump used. Otherwise, PoolManager® will not calculate the requisite pump runtime correctly for manual dosing, and the manual dosing amount won't be correct!	
Manual Dosing Amount	0.1...10.0 l	1.0 l
	Here, the desired dosing amount is set for manual dosing. PoolManager® calculates the duration of manual dosing based on the dosing amount and pump configuration. <b>Example:</b> For a pump configuration with 1.5 l/h and a dosing amount of 1.0 l, the manual dosing duration is 40 min.	
Manual Dosing Duration	1...240 min	40 min
	Here, the duration of manual dosing can be set. If this setting is changed, then PoolManager® also recalculates the dosing amount based on the pump configuration. <b>Example:</b> For a pump configuration of 1.5 l/h and a manual dosing duration of 30 min, the dosing amount is 0.75 l.	

Pressing the button *Start Manual Dosing* will start dosing.

**Note:**

In addition to manual input of the desired dosing amount, it is also possible to select a volume of single, double, or triple the basic dosing amount in case of O2 (Bayrosoft® Light) manual dosing.

**Ongoing dosing**

Menu view changes while a manual dosing is running. All relevant data for the ongoing dosing are now shown:

- **Current measured value pH / mV / Cl / Br**
- **Remaining time of the manual dosing in minutes**
- **Volume already dosed in the ongoing manual dosing in [l]**
- **Dosing Rate [%]**  
The only values that can appear here are 0 % or 100 %. If a dosing output of 0 % is shown, then manual dosing is blocked by an alarm or because there is no flow signal.
- **Dosing direction**  
The dosing direction of the current dosing is shown (D+ or D-)
- **Operation status pH / mV / Cl / Br / O2 (Manual / Flow / Alarm)**  
If manual dosing is running, then PoolManager® is in the operating mode "Manual."  
If, instead of this, "Alarm" or "Flow" is displayed, then manual dosing is blocked by an alarm or because there is no flow signal.

Manual dosing can be stopped at any time by pressing the button *Stop Manual Dosing*.

**16.3 Blocking via alarms**

Just like normal automatic dosing, manual dosing can be blocked by the following alarm statuses:

- **Flow signal missing**
- **Level alarm**  
(Depending on the configuration in the menu *Alarm Settings*)

- **Upper alarm**  
(blocks only manual dosing in D+ dosing direction)
- **Lower alarm**  
(blocks only manual dosing in D- dosing direction)

After the end of an alarm, the block on manual dosing is released and the remaining amount is dosed.

If manual dosing is started during start delay, then the start delay will end prematurely.

**16.4 Special case, shock chlorination**



**Required user qualification:**  
**TRAINED SPECIALIST**

Shock chlorination may only be performed by a TRAINED SPECIALIST as defined in the chapter *User qualification*.



**HAZARD!**  
**Overdosing via shock chlorination**

With shock chlorination, the standard chlorine concentration in the pool is usually significantly exceeded. Shock chlorination is *not* blocked by an upper alarm, such that the chlorine value can also rise to be significantly higher than the upper alarm threshold!

**Potential consequence: Gravest degree of injury, heavy material damage.**

- Calculate the correct dosing amount for shock chlorination carefully.
- Close off the pool for swimming following shock chlorination.
- Swimming may not take place again until the concentration of free chlorine has dropped below 5 mg/l (perform DPD measurement)!

Shock chlorination is a special kind of manual dosing. PoolManager® CI offers shock chlorination in the menu *Manual dosing mV (Chlorine)*. PoolManager® PRO offers shock chlorination in the menu *Manual dosing Chlorine*.

For shock chlorination, the dosing amount is calculated based on the pool volume. In doing so, the recommended amount of 1.0 litres of sodium hypochlorite per 10 m³ of pool volume is used as a basis. However, the calculated dosing amount can still be changed manually. For effective shock chlorination, the chlorine concentration in the pool should be at least 5 mg/l, better even 10 mg/l.

Pressing the button *Start Shock Chlorination* will start dosing.

Otherwise, the shock chlorination process corresponds exactly to normal manual dosing.

**16.5 Special case, pump test (pH / Cl / Br / mV / O2)**



**'HAZARD!**  
**Gaseous chlorine produced from dosing in standing water in a pump test**

If there is a dosing of chlorine during a pump test while circulation is not running, then gaseous chlorine may be produced when sodium hypochlorite meets with pH-Minus.

**Potential consequence: Death or the gravest degree of injury, heavy material damage.**

- Perform pump tests while circulation is running or without dosing of real product.

The pump test function is used to quickly check whether the individual dosing pumps are connected correctly and are fundamentally operational. There is *no* alarm block during a pump test, i.e., the corresponding pump should definitely be running during a pump test. If that is not the case, then there is an error in the pump or in the electrical connection.

The duration of the pump test is limited to a maximum of 60 seconds for safety reasons.

Otherwise, the pump test process corresponds exactly to normal manual dosing.

## 17 Safety functions and alarms

### 17.1 Overview

PoolManager® continuously monitors all relevant data and operating status in order to guarantee safe operation and optimum water quality.

If PoolManager® discovers a problem while doing so, then it will generate an alarm message notifying of the problem. Some alarms block product dosing until the alarm's cause has been remedied.

PoolManager® monitors the following alarm statuses.

- **Upper and lower measured value alarms (pH, mV, Cl, Br, temperature)**  
are triggered when there is a measured value outside the configured alarm thresholds.
- **Flow alarm (no flow signal)**  
is triggered when circulation is not running or if there is no measuring water flow for some other reason.
- **Level warning (pH, Cl, mV, O2)**  
is triggered when a canister with maintenance product (pH-Minus, sodium hypochlorite, or Bayrosoft® Light) contains only a certain residual amount (e.g., 5 l). The suction lance in the product canister delivers a corresponding signal once the threshold is reached.  
Level warnings and level alarms can be deactivated in the menu "Alarm Settings" if there is no suitable low-level signal available.
- **Level alarm (pH, Cl, mV, O2)**  
is triggered when a canister with maintenance product (pH-Minus, sodium hypochlorite, or Bayrosoft® Light) is empty.  
Level warnings and level alarms can be deactivated in the menu "Alarm settings" if there is no suitable low-level signal available.
- **Intelligent dosing monitoring (pH, Cl, Br, mV)**  
is triggered when PoolManager® does not successfully approach the setpoint within a predefined time (typically 60 minutes). In this case, PoolManager® will assume there is a potential problem and block further dosing.
- **Battery alarm**  
is triggered when the voltage on the buffer battery installed on the PoolManager® unit drops below the threshold of 2.70 V. In this case, the battery should be replaced within a few weeks. The buffer battery supplies PoolManager's® real-time clock with voltage while the mains supply is turned off.

## 17.2 Flow monitoring

### 17.2.1 Input terminal blocks for flow monitoring

PoolManager® offers two separate inputs for flow monitoring:

#### 17.2.1.1 Measuring water monitoring (standard)

Measuring water flow is usually monitored with an inductive proximity switch integrated into the measurement chamber. Flowing water raises the float in the measurement chamber. If the float rises to the level of the proximity switch, then the latter will supply the flow signal.



Inductive proximity switch (left) and float (right)

The proximity switch has three connection lines and is connected to PoolManager® terminal block [2] (*Flow*). The flow signal is ALWAYS monitored; this monitoring cannot be deactivated for safety reasons.

#### 17.2.1.2 Circulation monitoring (optional)

Optionally, an additional signal can be used to monitor the circulation circuit. For that purpose, usually a pressure switch is connected to PoolManager's® terminal block [6] (*IN1*). Alternatively, BNC connector *IN1 (Flow)* can be used, which is internally connected with terminal block [6] (*IN1*). In PoolManager's® default configuration, monitoring of this input is deactivated. It can be activated as needed in the menu *Alarm Settings (Flow Alarm Settings)*.

It is also possible to use the sensor connected to the *IN1* input instead of the inductive proximity switch as the sole sensor for flow monitoring. This option can also be configured in the menu *Alarm settings (Flow Alarm Settings)*.



#### HAZARD!

#### Gaseous chlorine produced from dosing in standing water via unreliable flow monitoring.

If only one single sensor on input *IN1* is being used for flow monitoring, then there is risk for dosage in standing water in the event of an error. Poisonous chlorine gas can be yielded when sodium hypochlorite and pH-Minus come together.

#### Potential consequence: Death or the gravest degree of injury, heavy material damage.

- Ensure that the sensor being used is functioning reliably.
- Ensure that PoolManager® dosing pumps are only supplied with power while circulation is running; see section "Blocking via the circulation pump".

### 17.2.2 Automatic / manual acknowledgement

PoolManager® offers two different options for handling a missing flow signal:

#### 17.2.2.1 No alarm in case of missing flow signal (Default, Acknowledge Flow Alarm = Auto)

In this option, PoolManager® does not assess a missing flow signal as an error, but rather as a normal operating state. For many swimming pools, circulation only runs in intervals and not around the clock. In this case, it is entirely normal for PoolManager® to not receive a flow signal in times without circulation.

Accordingly, PoolManager® signals the missing flow signal only as a normal operating status, not as an alarm status. The special mechanisms for signalling alarms are not activated (blinking display, acoustic alarm, etc.).

Dosing is blocked for as long as no flow signal is present. Once the flow signal returns and the start delay has passed, PoolManager® automatically returns to normal operation.

### 17.2.2.2 Alarm in case of missing flow signal (Default, Acknowledge Flow Alarm = Manual)

This option is only sensible for swimming pools where circulation runs around the clock without interruption. PoolManager® assesses a missing flow signal as a severe error that is signalled with various alarm mechanisms.



#### IMPORTANT NOTICE!

##### Manual acknowledgement of a flow alarm

After the flow signal returns, dosage remains blocked in this option. Blocking is not released until after the flow signal has returned **and** the flow alarm has been acknowledged manually.

### 17.3 Start delay

After turning on PoolManager® or once the flow signal has returned after an interruption (e.g., after turning circulation back on), a configurable delay is initiated. PoolManager® will wait for that period of time so that all measured values can stabilize. No dosing is performed during a start delay. Regular operation does not start again until the start delay has passed.

The start delay is displayed as follows in the *Alarm Overview*:



The first line shows the current remaining runtime of the start delay in [min]. The second line makes it possible to end start delay prematurely by pressing the acknowledgement button ("Quit").

### 17.4 Alarm signalisation

PoolManager® uses multiple mechanisms for clearly signalling alarms to the user:

- **Flashing of the entire display**  
Flashing ends immediately upon touching the touchscreen.
- **Automatic jump to the menu *Alarm Overview***  
Note: The menu *Alarm Overview* can also be called up at any time as follows:



Menu hotkey



Alarm Overview

- **Acoustic alarm signal**  
(Provided this function is activated for the corresponding alarms in the menu *Alarm Settings*)  
The acoustic alarm signal ends immediately upon touching the touchscreen.
- **Alarm relay connection**  
Switch output (volt-free or mains power 230 V~) for connecting external systems to signalise or record alarm status (terminal block [25] (*Alarm*)).  
See section *Alarm relay*.
- **Alarm display in home view**

Alarms are shown in the alarm overview as follows:



- 1 The alarm is active, i.e., the alarm cause has not yet been remediated. But the alarm has already been acknowledged. Therefore, the acknowledgement button is no longer displayed.
- 2 The alarm is active, i.e., the alarm cause has not yet been remediated. The alarm has not yet been acknowledged. Therefore, the acknowledgement button is displayed.
- 3 The alarm is no longer active, i.e., the alarm cause has been remediated. That is why the alarm appears in brackets. However, the alarm has not yet been acknowledged. Therefore, the acknowledgement button is displayed.

If an alarm becomes inactive, i.e., the alarm cause has been remediated, *and* the alarm has been acknowledged by the user, then it will disappear completely from the alarm overview.

No acknowledgement button appears for the flow report if the setting *Acknowledge Flow Alarm* is set to *Auto*, as no acknowledgement is required in that case.

#### 17.4.1 Alarm display in the "Home" view

All active alarms are displayed in the "Home" view; see section *Home view*.

#### 17.5 Blocking of dosing via alarms

Alarms generally result in blocking of dosing. Blocking is automatically released as soon as the alarm cause has been remediated.

It is not necessary for a user to acknowledge an alarm in order to end blocking (however, the alarm continues to be displayed in *Alarm Overview* until acknowledgement).

The following alarms are handled in deviation to that mechanism:

- If the setting *Acknowledge Flow Alarm* is set to *Manual*, then blocking of dosing is not ended until a flow signal is present again **and** the flow alarm has been acknowledged by the user. Dosing will then be released after start delay has passed.
- If the setting *Acknowledge Flow Alarm* is set to *Automatic*, then dosing will be released after the start delay once the flow signal is present again.
- The menu *Alarm Settings* can be used to configure whether a level alarm will lead to blocking of dosing. The default setting is that a level alarm will block dosing of the respective control module (pH, mV, Cl, Br, O2).
- After a dosing alarm, dosing is released immediately after manual acknowledgement of the alarm.

## 17.6 Table overview

Alarm	Blocking of dosing	Notes
Upper alarm (pH, mV, Cl, Br)	Only for dosing direction D+ (only for the respective control module)	Blocking is released as soon as the measured value drops back below the upper alarm threshold
Lower alarm (pH, mV, Cl, Br)	Only for dosing direction D- (only for the respective control module)	The block is released as soon as the measured value climbs back over the lower alarm threshold
No flow signal	Yes (for all control modules)	<i>Acknowledge Flow Alarm = Auto</i> Start delay will first run after the flow signal returns. Dosing is then released again. No acknowledgement required.
No flow signal	Yes (for all control modules)	<i>Acknowledge Flow Alarm = Manual</i> Start delay will first run after the flow signal returns <b>and</b> the alarm is acknowledged. The dosing is then released again. Manual acknowledgement is required.
Level alarm (pH, mV, O2, Cl)	Yes (Only for the respective control module), can be deactivated in the menu <i>Alarm Settings</i>	After the level signal returns, dosing is released again.
Dosing alarm (pH, mV, Cl, Br)	Yes (for the respective module only)	After acknowledging the dosing alarm in the <i>Alarm Overview</i> , dosing is released again.
Start delay	Yes (for all control modules)	Start delay runs through its time after starting PoolManager® and after the flow signal returns. Dosing is released after that time has passed. Start delay can be prematurely ended via manual acknowledgement in <i>Alarm Overview</i> .
Battery alarm	No	



### INFO

#### Alarm delay

All alarms are shown only after an alarm delay of 5s. They are also not deleted until the alarm's cause has been remediated for at least 5s. The alarm delay for the flow alarm can be extended as needed in the menu *Alarm Settings*.

## 17.7 Alarm settings

The following adjustments can be made in the menu *Alarm Settings*.

### 17.7.1 Acoustic alarms

The following acoustic alarms can be activated and deactivated individually:

- Acoustic signal for flow alarm
- Acoustic signal for level alarm
- Acoustic signal for level warning
- Acoustic signal for other alarms
- Acoustic signal for Service Messages

## 17.7.2 Flow alarm settings

- Duration of start delay
- Alarm delay for the flow alarm
- Flow alarm acknowledgement (automatic / manual)
- Input for flow monitoring:
  - Flow [2]
  - IN1 [6] / BNC
  - Flow [2] & IN1 [6] / BNC (Double flow monitoring)

### 17.7.3 Level alarm settings

- Level alarm pH active / inactive (Level alarm can be deactivated if no low-level signal is available)
- Level alarm Cl / mV / O2 active / inactive (Level alarm can be deactivated if no low-level signal is available)
- Optional level input for pH-Plus
- Dosing at level alarm (yes / no) (If the canister is not yet entirely empty when a level alarm arises, then dosing can be continued despite level alarm)

Sub-menu *Configuration of Residual Volumes*

- Residual volumes in canister at level signal from suction lance, i.e., when a level warning is indicated, e.g., 5.0 l (individually configurable for each canister)
- Calculated residual volumes at which a level alarm is indicated, e.g., 0.5 l (individually configurable for each canister)

### 17.7.4 Use alarm relay

If the alarm relay is not used, *use alarm relay* can be changed to *No*. In this case, the alarm relay is available for add-on functions.

## 17.8 Alarm relay

The alarm relay offers the chance to connect an external alarm device, or to notify external systems of alarms, e.g., Building Management Systems.

The alarm relay is turned on as long as there is at least one active alarm, **and** it has not yet been acknowledged.

### 17.8.1 Electrical connection



#### Required user qualification:

#### ELECTRICAL SPECIALIST

An electrical connection to an alarm relay may only be performed by an ELECTRICAL SPECIALIST as defined in the chapter *User qualification*.



#### IMPORTANT NOTICE!

#### Do not exceed the maximum currents

Do not exceed the maximum permissible electrical currents for the alarm relay (max. 4 A) and for the sum of all relay switch outputs being used in 230 V~ configuration (in sum, also max. 4 A)

Please also refer to the Chapter 230 V~ Power supply.



The following figure shows the internal wiring on the alarm relay. All connections shown are run internally as conducting paths.

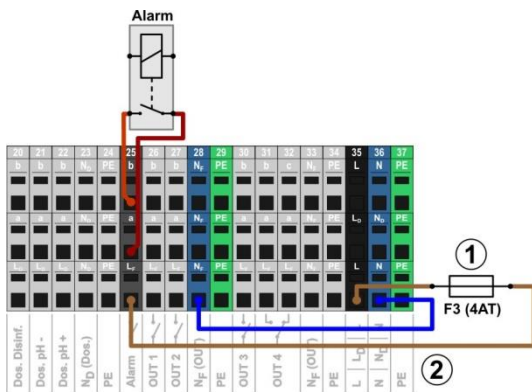

- pH-
- 1 Fuse F3 (4 A slow)
  - 2 230 V~ phase L<sub>F</sub> for the alarm relay and the add-on functions (secured with 4 A)

The terminal block [25] for the alarm relay is set up as follows:

Terminal	Function
b	Working contact
a	Centre contact
L <sub>F</sub>	Supply phase 230 V~ for alarm relay and add-on functions. Can be bridged to the centre contact in order to control 230 V~ devices.

The following figure schematically shows the connection of a 230 V~ alarm device on the alarm relay.

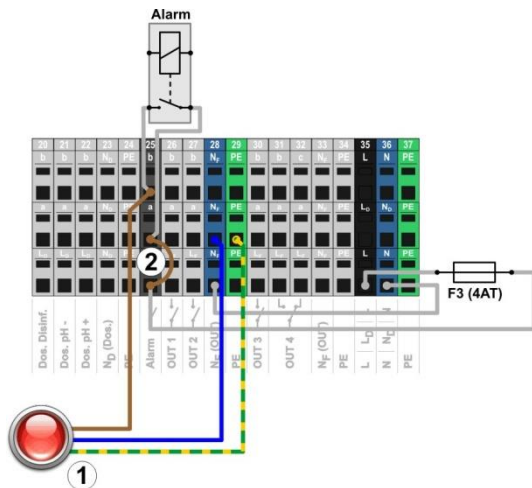

- 1 Alarm device 230 V~ (e.g., lamp)
- 2 Wire bridge in the terminal box from phase L<sub>F</sub> to centre relay contact a



**INFO**

**Connection of neutral conductor N and PE**

An alarm device's neutral conductor N and protective earth PE can be connected to the N<sub>F</sub> and PE terminal blocks as shown in the figure.

When using the alarm relay as a volt-free switch, the wire bridge (2) is omitted, and the connection is realised on terminal blocks [25a] and [25b].

**18 Service messages**

The menu *Service Messages* is called up as follows:



Menu hotkey



Service Messages

The function *Service Messages* facilitates targeted planning of certain service processes:

- **Calibration (pH, mV, Cl or Br, T)**  
Recommended interval: 1 month
- **Electrode replacement (pH, mV, Cl or Br, T)**  
Recommended interval: 12 months
- **Hose replacement on the dosing pump (pH, mV, O<sub>2</sub>, Cl)**  
Recommended interval: 12 months

A time interval in [months] can be defined for each service process in the sub-menu *Service Intervals*. After the configured period of time has passed, PoolManager® will automatically provide a reminder that the planned service process is due.

The default setting for all service intervals is 0 months, i.e., inactive. In order to activate the function, an interval of 1...60 months has to be set for the service processes desired. Resetting to 0 months will deactivate the service message again.

In the menu *Service Messages*, all planned service processes are shown along with their due date. If needed, the planned date calculated by PoolManager® can be modified manually.

The service processes are displayed in the menu as follows:



- 1 These service messages are already due. Therefore, an acknowledgement button ("Quit") is displayed. Pressing the acknowledgement button will reschedule the process and the newly calculated due date will be displayed.
- 2 These service messages are not yet due. Therefore, the due date is displayed.

### 18.1 Signalising due Service Messages

Due service messages are signalised as follows:

- **Flashing of the entire display**  
Flashing ends immediately upon touching the touchscreen.
- **Automatic jump to the menu *Service Messages***  
Note: The menu *Service messages* can also be called up at any time as follows:



Menu hotkey



Service Messages

- **Acoustic alarm signal**  
(Provided the function *Acoustic signal for Service Messages* is activated in the menu *Alarm Settings*)  
The acoustic alarm signal ends immediately upon touching the touchscreen.

**Note:**

Due service processes are signalised at 8:00 a.m. on the corresponding day.

### 18.2 Re-scheduling service messages

When re-scheduling, PoolManager® recalculates the due date of a service message by adding the configured service interval to the current date.

**Example:**

- For pH calibration, a service interval of 3 months is configured.
  - On 6 December 2022, it will be re-scheduled.
- ⇒ The new due date is 6 March 2023.

Service messages are re-scheduled in the following cases:

- Change to the service interval in the menu *Service Intervals*
- Acknowledgement of a due service message
- Successful calibration (for calibration messages only)
- Calling up the function *Re-schedule service messages* in the menu *Service intervals*

## 19 Eventlog

The *eventlog* is called up as follows:



Menu hotkey



Eventlog

The event log is a record of all important events involving PoolManager® with date and time. PoolManager® has memory for up to 500 events. When that number is met, the oldest events are overwritten with new ones.

The event log is an important tool in controlling proper operation of the swimming pool system and analysing potential problems.

### 19.1 Events

The following events are logged individually in the event log:

- PoolManager® power on and off
- Alarms (start and end)
- Calibration with detailed calibration data
- Parameter changes with old and new value
- O2 dosings and average temperature values
- Manual dosings
- Dosed product volumes
- Remote access
- Software updates
- Access code reset
- Reset to default values

PoolManager® displays all entries in the event log in an easy-to-follow manner. That is why there is no detailed presentation of the individual events in this manual.

### 19.2 Information displayed

For each event, the following supplemental information is stored and displayed in the event log:

- Date and time
- User  
(Provided a user can be allocated to the event, e.g., parameter changes, calibrations, manual dosing, etc.)
- Type of access
  - Local operation (*local*)
  - Remote access from the local network (*LAN*)
  - Remote access from the Internet (*Web*)

#### 19.2.1 Event display

Here is a detailed explanation of how an event is displayed using the example of a parameter change:

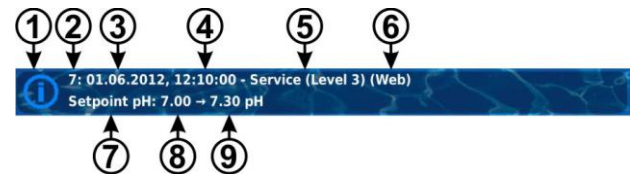

- 1 Symbol (depending on type of event)
- 2 Consecutive number of the event
- 3 Date
- 4 Time
- 5 Username and access level, e.g. *Service (Level 3)*
- 6 Type of access (*local / LAN / Web*)
- 7 Designation of changed parameter
- 8 Old parameter value (prior to change)
- 9 New parameter value

### 19.2.2 Example, O2 (Bayrosoft® Light) dosing

This example of O2 (Bayrosoft® Light) dosing is intended to show the benefits of the eventlog:

```

1 06.06.2022 08:44
  Main dos.O2 ended (2.4/2.4l)
2 06.06.2022 08:30
  Main dos.O2 continued(1.0/2.4l)
3 06.06.2022 08:30
  (Level alarm) end
4 06.06.2022 08:10
  Main dos.O2 blocked (level)
5 06.06.2022 00:10
  Level alarm O2
6 06.06.2022 00:00
  Main dos.O2 started (2.4l)
    
```

This series in the eventlog is caused by the following events

- At midnight, PoolManager® starts O2 main dosing with a dosing amount of 2.4 litres.
- After 10 minutes, however, the Bayrosoft® Light canister is empty. That triggers a level alarm, which blocks O2 main dosage.
- On the next morning at 8:30 a.m., the empty Bayrosoft® Light canister is replaced.
- The level alarm ends, and O2 main dosing is continued. There was already 1.0 litre of Bayrosoft® Light dosed prior to the level alarm. Thus, another 1.4 litres need to be dosed.
- At 8:44 a.m., the O2 main dosing ends regularly after the dosing amount of 2.4 litres is fully met.

## 20 Controller settings

The menu *Controller settings* is called up as follows:



Menu hotkey



Controller settings

The menu provides the following setting options:

Menu Controller settings	
Menu language	Configuration of the desired menu language
Menu style	See section <i>Individualisation</i>
Icon style	
Background image	
Controller name	Entry of a name for the PoolManager® unit. This name is shown in the browser during remote access and makes it possible to distinguish among multiple controllers.
Date & time	Set system date and time, and configuration of associated options
Power down mode	Settings for the energy saving power down mode of PoolManager®

### 20.1 Date & Time

The following functions are available in the menu *Date & Time*:

Menu Date & Time	
Time	Display and configuration of current time
Date	Display and configuration of current date
Weekday	Display of current weekday. The weekday is automatically set correctly upon setting the date.
Summer / wintertime auto / manual	Configuration of the change between summer and winter time. <i>Auto</i> The change is made automatically <i>Manual</i> The change is made manually by the user Standard setting (default): Auto
Time +1h	The current time is moved forward by one hour
Time -1h	The current time is moved back by one hour

PoolManager® automatically sets time as follows in automatic configuration for summer / wintertime:

- On the last Sunday in March, time is moved forward from 2:00 a.m. to 3:00 a.m.
- On the last Sunday in October, time is moved back from 03:00 a.m. to 02:00 a.m.

Once the automatic change has been made, the unit will show a notification.

When power down mode is activated, PoolManager® reduces screen brightness and enters an energy saving mode after a configured amount of time. A simple touch ends energy saving mode and increases the screen's brightness again.

This function can be configured in the menu *Power down mode*

Menu Power down mode	
Power down time	Time in [min] after which power down mode is activated when no user entries are made.
Power down mode (active / inactive)	Activates or deactivates power down mode.

## 21 Service functions



**Required user qualification:**  
**TRAINED SPECIALIST**

The functions in the menu *Service Functions* may only be used by a TRAINED SPECIALIST as defined in the chapter *User qualification*.

The menu *Service Functions* is called up as follows:



Menu hotkey



Service Functions

This menu has special functions for service staff that are needed, for example, for the system's basic configuration (pool volume, configuration of dosing pumps, etc.).

Furthermore, a software update can be performed, or the care method (Cl / Br / O2) can be changed.

Specifically, the menu offers the following functions:

Menu <i>Service Functions</i>	
Pool volume	Pool volume in [m³]
Configuration of dosing pumps	Configuration of dosing pump parameters (Standard pump or membrane pump, dosing capacity). See section <i>Dosing pumps</i> .
Device information and test functions	Display of battery voltage (Buffer battery for internal real-time clock), future test functions.
Reset to defaults	Reset of all parameter settings to default settings.
Commissioning Step by step	Call-up menu sequence for first commissioning. See section <i>Commissioning</i> .
Software update (from USB stick)	Update of the PoolManager's® internal software. To do so, the new software has to be copied to a USB memory stick. See section <i>Software update (from USB stick)</i> .
Management of system configurations	Import and export of complete system configurations via remote access or USB stick. See section <i>Management of system configurations</i> .
Controller Model and Care Method	Configuration of the PoolManager's® care method (Cl / Br / O2)
Trade show settings	Activation of special functions for trade shows and training sessions (e.g., internal simulation of measured values)
Master level functions	Special functions for users with Master (level 4) access rights. Separate documentation is available for these functions as needed.
Use intelligent dosing alarm	Activate or deactivate intelligent dosing monitoring. If deactivated, the "classic" dosing time alarm is used, i.e., a dosing time alarm is indicated, if the setpoint has not been reached within the specified max. dosing time.
Commissioning On / Off	If set to <i>On</i> , PoolManager® will automatically start the Commissioning sequence after power on. This is the standard configuration for new controllers from the factory.

### 21.1 Management of system configurations

This menu provides you with a wide range of options to load or save entire system configurations. The source or destination can be a PC in remote access or a USB memory stick. Furthermore, PoolManager® can also internally store four more configurations in addition to the active configuration.

You can select one system configuration as the source and transfer it into another system configuration (destination). The current active system configuration can also be used as a source or a destination.

A system configuration includes all PoolManager® parameter settings. The only exclusions are:

- Access data (usernames, access codes, passwords)
- Care method
- Network (IP) settings

An easy-to-follow name can be assigned to every copied configuration in order to distinguish various configurations from each other.

## 22 User management

PoolManager® delivers comprehensive, flexible, and powerful user administration. This makes it possible to define individualised access rights for each of the system's users. Furthermore, the rights for remote access can also be configured very flexibly for each individual user. In doing so, it's even possible to make a distinction between remote access from the local network and from the Internet, i.e., you can release more functions for remote access from the local network than for remote access from the Internet as needed.

### 22.1 Menu User Management

The menu *User Management* is called up as follows:



Menu hotkey



User Management

The menu contains multiple sub-menus with the following configuration options:

<b>Menu <i>User administration</i></b>
<b>Standard users (menu access only)</b>
This sub-menu can be used to configure access codes for standard users. See section <i>Standard users</i> .
<b>Individual users (menu &amp; remote access)</b>
This sub-menu can be used to create individual users and configure their rights. Remote access from the local network or from the Internet can be released for individual users. See section <i>Individual users</i> .
<b>Enable remote access for various functions</b>
This sub-menu can be used to release or block certain functions for remote access. See section <i>Enable remote access for various functions</i> .
<b>Enable remote access for add-on functions</b>
This sub-menu can be used to release or block remote access for all add-on functions. See section <i>Enable remote access for various functions</i> .
<b>Adjust user levels for various functions</b>
This sub-menu can be used to set required user level for certain functions. See section <i>Adjust user level for functions</i> .

The individual menus and functions are described in the detail in the following sections.



## 22.2 Users

You have to login as a user in order to receive access rights for certain functions on PoolManager®.

For menu access, select a username and enter the correct access code for the selected username (max. 6 digits).

During remote access, logging in with a separate username (only for remote access) and a password is required.

There are two different types of users on PoolManager®:

### 22.2.1 Standard users

Standard users are predefined users that are ALWAYS available.

Standard users	
Designation	Description
Guest (level 0)	May look at menus and parameters but cannot modify settings or execute functions.
Customer (level 1)	May modify some settings that are neither relevant to safety nor critical to function.
Customer (level 2)	May modify comprehensive settings that are not relevant to safety.
Service (level 3)	May modify all settings and execute all functions. The only exceptions to this are several special functions for which master or factory user level is required.
Master (level 4)	May additionally execute several special functions (e.g., special reset functions).
Factory (level 5)	May additionally execute several factory functions (e.g., testing and reset functions).

You can find a detailed overview of user rights in the section *Overview of user rights*.

For each of the available user levels (level 1 to level 5), a standard user is predefined. Furthermore, a changeable access code is assigned to each standard user, which must be entered correctly for authentication to get access to protected parameters or menus.

### 22.2.2 Individual users

Additionally, to the predefined standard users, up to 5 individual users can be created.

For each individual user, there is a separate configuration menu in which the following settings are available:

Menu sequence <i>User x Configuration (x = 1..5)</i>	
Step 1: Menu access configuration	
Username (1..5) (menu access)	Username for menu access (A separate username must be established for remote access)
Access code (1..5) (menu access)	Access code for authentication of that user (Code no. with max. 6 digits)
User level (menu access)	User level for this user for menu access: <ul style="list-style-type: none"> <li>• Customer (level 1)</li> <li>• Customer (level 2)</li> <li>• Service (level 3)</li> <li>• Master (level 4)</li> </ul>



#### HAZARD!

#### Unauthorised access possible from using known access codes

Access codes facilitate access to critical areas on the system. Unauthorised access can lead to dangerous configurations.

#### Potential consequence: Death or the gravest degree of injury, heavy material damage.

- Configure individualised access codes. Under no circumstances should the preconfigured standard access codes be used.
- Keep access codes strictly confidential.



#### IMPORTANT NOTICE!

#### Availability of access codes

Ensure that all access codes are known and available as needed, even after longer periods of time. The access codes are absolutely necessary for numerous functions and settings!

### 22.2.2.1 Remote access

Remote access can only be released in connection with an individual user. Remote access can be released and individually configured for each individual user. A separate user level can be defined for remote access that can be restricted compared to the user's user level for menu access.

The following settings are available for remote access in the corresponding sub-menu *Remote access configuration*

Menu sequence <i>User x Configuration (x = 1..5)</i>	
Step 2: Remote access configuration	
Username (1..5) (remote access)	Username for remote access. The username must be entered correctly when logging on for remote access.
Password (1..5) (remote access)	Password for remote access. This password must be entered correctly when logging on for remote access.
User level (remote access)	User level for remote access: <ul style="list-style-type: none"> <li>• Inactive (no remote access)</li> <li>• Guest (level 0)</li> <li>• Customer (level 1)</li> <li>• Customer (level 2)</li> <li>• Service (level 3)</li> <li>• Master (level 4)</li> </ul> The user level for remote access cannot be higher than the general user level for menu access for this individual user. It can be lower or identical.

- Standard level for remote access is *Guest (level 0)*, i.e., settings cannot be modified.
- Settings can only be changed in remote access if the user level is raised accordingly.



#### HAZARD!

#### Unauthorised access

Despite the highest security standards, there is fundamentally a residual risk for potential unauthorised access when releasing remote access. Unauthorised access can lead to dangerous configurations.

#### Potential consequence: Death or the gravest degree of injury, heavy material damage.

- Do not use trivial usernames or passwords
- Keep usernames and especially passwords strictly confidential
- Restrict user rights for remote access according to your individual security needs in a sensible manner.
- Only release remote access for the user level actually needed.
- Where possible, only use remote access on the local network and secure the local network against unauthorised access via the available protection standards.
- If necessary, use additional security standards for Internet remote access, e.g., VPN (virtual private network)

22.3 Overview of user rights

▼ Function	User level ►	Guest (Level 0)	Customer (Level 1)	Customer (Level 2)	Service (Level 3)	Master (Level 4)	Factory (Level 5)
<b>Standard access code</b>		-	1234	5678	8642	xxxx	xxxx
Complete menu navigation "See everything - change nothing"							
Setting uncritical parameters							
Setting parameters critical to function							
Setting parameters relevant to safety							
Call-up Mode menu							
1-point calibration							
2-point calibration							
Manual dosing							
Acknowledge acoustic alarms							
Acknowledge alarms							
Acknowledge service messages							
Master (level 4) - Special functions							
Factory (level 5) - Special functions							



Function permitted for the corresponding user level

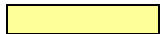

Function not permitted for the corresponding user level but can be released in the menu by system operator.

22.4 Enable remote access for various functions

In the menu *Enable remote access for various functions*, you can define whether remote access is allowed or not for various functions. It is possible to configure the following settings:

Allow remote access	
Inactive	Remote access to the corresponding function is blocked.
Local network	Remote access to the corresponding function is released on the local network only, but not on the Internet (Web).
Local network & Web	Remote access to the corresponding function is released both on the local network and on the Internet (Web).

Remote access can be released or blocked for the following functions:

Sub-menu <i>Configure access rights for remote access</i>	
Allow remote access to Mode menu	Release of the Mode menu for remote access Depending on the system configuration, critical functions might be turned on and off accidentally during remote access to the Mode menu. That is why the default setting blocks remote access to the Mode menu.
Allow remote access for calibration	In general, calibration has to be performed on-site. That is why the default configuration blocks remote access to calibration. If needed, however, calibration can be released for remote access if, for example, a mobile device is going to be used on-site.
Allow remote access for manual dosing	In general, manual dosing has to be performed on-site. That is why the default setting blocks remote access to the manual dosing. If needed, however, calibration can be released for remote access if, for example, a mobile device is going to be used on-site.

22.5 Adjust user levels for various functions

In the menu *Adjust user levels for various functions*, the required user level for access to various functions can be adjusted as needed:

Sub-menu <i>Adjust user level for various functions</i>	
User level for 1-point calibration	Required user level for 1-point calibration. Potential settings: • Customer (level 1) • Customer (level 2)
User level for manual dosing	Required user level for manual dosing. Potential settings: • Customer (level 1) • Customer (level 2)
User level for Mode menu	Required user level for access to the Mode menu. Potential settings: • Customer (level 0) (⇒ no login!) • Customer (level 1)
Mode menu safety notice	The safety advice which is usually displayed when calling up the Mode menu, can be deactivated here

## 22.6 User login with access code

Most parameter changes and access to some menus require authentication with a certain user level. If authentication is required, then the menu *User login* will appear automatically.

In this menu, first select the user you would like to use for login. Then enter the correct access code for the selected user. If the access code entered is correct, then you'll be granted access to the desired parameter or menu.

- After successful login, the corresponding user level will remain valid until you return to home view; or, after several minutes the screen is returned to Home view automatically.
- No new login is necessary for as long as the user level is still valid. The menu *User login* will only appear again for accessing functions requiring a higher user level.

The menu *User login* is set up as follows:

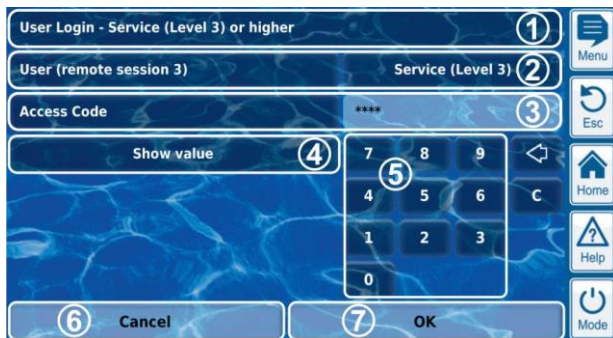

- 1 Menu title indicating the requisite minimum user level for the desired function
- 2 Selection of the desired user.  
The default setting is that the last selected user is displayed if that user's level is sufficiently high. Otherwise, the standard user is displayed with the requisite minimum user level.
- 3 Enter access code for the selected user.
- 4 The default setting is for the entered code to be masked (\*\*\*\*). This button can be used to display the actual code.
- 5 Number keypad for code entry.
- 6 Cancel will close the entry screen.
- 7 OK confirms the entries. Once authentication has been successful, you'll be forwarded to the desired menu.



Delete the last number



Delete the entire access code

### 22.6.1 User selection

If the user selection screen is opened in the menu *User login* (2), then it will be displayed as follows:



- 1 Menu title, with indication of session (Local or remote access)
- 2 Currently selected user (white background)
- 3 Further potential for the desired function (White lettering)
- 4 Users to whom access to the desired function is not granted (grey lettering)
- 5 Default user
- 6 Cancel will close the selection screen.
- 7 OK will confirm the selection and return to the menu *User login*.

There may be various causes for a user not being selectable and therefore being displayed in grey lettering:

- The user level is too low for the desired function
- Only for remote access:  
The required user level for the desired function is higher than that of the current user in remote access

## 23 Communication & Interfaces

The menu *Communication & Interfaces* is called up as follows:



Menu hotkey



Communication & Interfaces

The menu contains multiple sub-menus with the following configuration options:

<b>Menu Communication &amp; interfaces</b>
<b>Network (IP) configuration</b>
In this sub-menu, the network settings (IP settings, IP = Internet protocol) are made for remote access from the local network. See section <i>Remote access from the local network</i> .
<b>E-mail configuration</b>
This sub-menu configures the options for sending e-mails via PoolManager®. See section <i>E-mail functions</i> .
<b>Data import &amp; export</b>
This sub-menu provides import and export functions for various data: <ul style="list-style-type: none"> <li>• Measurement graph (export)</li> <li>• Eventlog (export)</li> <li>• Individual background images (import)</li> </ul> See section <i>Data import &amp; export</i>
<b>CAN bus interface</b>
This sub-menu configures the CAN bus for the connection of future add-on boxes (feature boxes). Please refer to the separate documentation for the corresponding feature box for more information.
<b>4-20 mA current loop outputs</b>
This sub-menu configures the PoolManager® optional 4-20 mA current loop outputs. These outputs are available as an optional add-on module (internal plug-in module with 4 outputs 4-20 mA): <b>PM5-SA4 CONVERTER 4-20MA (Art. no. 127011)</b> The current loop outputs can be used for the following functions: <ul style="list-style-type: none"> <li>• Transmitting measured values (pH, mV, Cl / Br, temp.) as 4-20 mA current loop signal (for data recorders, remote displays, building management systems)</li> <li>• Controlling external systems (e.g., variable filter pumps, salt electrolysis systems)</li> </ul> For more details, please refer to the separate documentation for the <b>PM5-SA4 CONVERTER 4-20MA (Art. no. 127011)</b> .

### 23.1 Data import and export

The menu *Data import and export* provides functions for importing and exporting various data:

- **Export measurement graph**
  - Download measurement graphs from the PoolManager® (in remote access from a PC)
  - Store measurement graphs to USB stick
  - Automatic e-mail transmission of measurement graph (every 1...7 days to up to 3 e-mail recipients)
  - In order to use the export functions for the measurement graph, Automatic storage of measurement graphs has to be activated in advance. This automatically saves daily measurement graphs in PoolManager® for later export.
- **Export eventlog**
  - Download eventlog from the PoolManager® (in remote access from a PC)
  - Store eventlog to USB stick
- **Load individual background images**
  - Load background image to the PoolManager® (in remote access from a PC)
  - Load background image from USB stick
- **USB memory stick data import & export**
  - Save measurement graphs to USB stick
  - Save event log to USB stick
  - Load background image from USB stick



#### INFO

##### Measurement graph export

To export measurement graphs, a start date and an end date have to be selected first. This will then export the measurement graphs available for the time frame indicated.



#### INFO

##### Requirements for individual background images

- Image size 800x480 pixels
- JPEG format
- Max. 300 kB



#### INFO

##### Load individual background images from USB stick

The images on the USB stick have to be in a sub-directory \pm5\_image and meet the requirements listed above.



#### INFO

##### Save measurement graph to USB stick

Measurement graphs are stored to a USB stick in the directory \pm5\_graph



#### INFO

##### Save event log to USB stick

Event logs are stored to a USB stick in the directory \pm5\_log



#### INFO

##### Inserting and removing a USB memory stick

See chapter *USB interface*.



### 23.2 E-mail functions



**Required user qualification:**  
**IT SPECIALIST**

Setting up e-mail functions, especially accounts for sending e-mail (SMTP) may only be performed by an IT SPECIALIST as defined in the chapter *User qualification*.

If PoolManager® has a connection to the Internet (see *Remote access from the Internet*), then it is able to send e-mails.

The following functions can then be realised:

- Alarm e-mails
- Automatic transmission of measurement graphs

E-mail functions are configured in the menu *E-mail configuration*. There, the following options are available:

<b>Menu E-mail configuration</b>
<b>Recipient e-mail address configuration</b>
This sub-menu can be used to configure up to three recipient e-mail addresses and to activate or deactivate them individually.
<b>Account for sending e-mails (SMTP)</b>
In this sub-menu, the account is set-up that PoolManager® uses for sending e-mails. To do so, you'll need an SMTP account from an e-mail provider (SMTP = simple mail transfer protocol) and need to have the corresponding access information available.
<b>Alarm e-mails</b>
You can use this sub-menu to configure the cases in which recipients will receive alarm e-mails.
<b>Send test e-mail</b>
This function sends a test e-mail to the active e-mail recipients.

## 24 Add-on functions

PoolManager® provides comprehensive add-on functions for intelligent control of numerous systems in the swimming pool environment.

You can call up the menu *Add-on functions* at any time as follows:



Menu hotkey



Add-on functions

The menu *Add-on functions* is realised as an icon menu. Every individual add-on function is represented by its own icon.

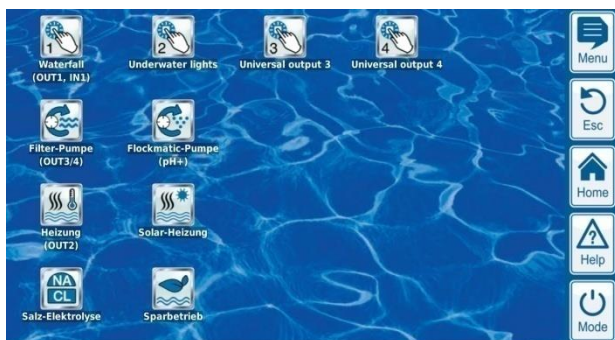

The individual add-on functions are described in detail in the following sections.

## 25 Universal switch outputs (4x)

### 25.1 Safety information



**Required user qualification:**  
**TRAINED SPECIALIST or ELECTRICAL SPECIALIST**

Connection, configuration, and start-up of universal switch outputs may only be performed by a TRAINED SPECIALIST, or an ELECTRICAL SPECIALIST as defined in the chapter *User qualification*.



**HAZARD!**

**Hazardous applications**

Universal switch outputs can fundamentally be used for the widest variety of functions. Depending upon the application, switching processes or the switched function could produce hazards.

**Potential consequence: Death or the gravest degree of injury, heavy material damage.**

- The use of universal switch outputs is expressly PROHIBITED for all applications in which the safety of persons, animals, and property is not completely guaranteed at all times and under all circumstances.
- It is particularly prohibited to connect sauna heaters without the corresponding safety precautions (fire hazard!)
- It is particularly prohibited to open and close swimming pool covers without the corresponding safety precautions (danger of drowning!)
- Safety is exclusively in the system operator's sphere of responsibility.
- The system operator must perform a hazard analysis for every application planned.
- The controller manufacturer disclaims all liability.

### 25.2 Overview

PoolManager® provides four universal switch outputs that facilitate intelligent and highly flexible control of water attractions and other functions in the swimming pool environment.

There is a relay switch with the corresponding connection terminal assigned to each switch output.

The particular features of the universal switch outputs are:

- Operation optionally as volt-free switch or as 230 V~-output
- Freely selectable names
- Flexibly programmable timers for each switch output
- Interval operation possible (turning on and off periodically)
- Potential blocking in the event of missing flow
- Potential blocking dependent upon the filter pump's operation
- Potential blocking via an input
- Potential blocking via another output
- Link with an external switch or push-button
- Remote access can be individually released or blocked for each individual switch output
- Show in the Mode menu can be individually released or blocked for each individual switch output

### 25.3 Configuration menu

The configuration menus for each individual switch output are set up identically.

They are called up via the icons



**INFO**

**Designation of universal switch outputs**

In all menus in which the universal switch outputs appear, the switch output designation you entered will be indicated (e.g. *Waterfall*)

The following settings are available:

Configuration menu for universal switch outputs	
<b>Name</b>	Entry of the freely selectable name (designation) for the switch output.
<b>Operating mode</b>	Selection of operating mode: <ul style="list-style-type: none"> <li>• Inactive (Switch output not used)</li> <li>• Off (Switch output used, but turned off)</li> <li>• On</li> <li>• Timer</li> </ul>
<b>Timer function</b>	Activate the switch output once for a specified switch-on time.
<b>Programmable timer</b>	Programming timers.
<b>Basic configuration</b>	Basic settings for the switch output.
<b>Safety settings</b>	Safety settings for the switch output.



**INFO**

**Allocation of a relay switch output**

A universal switch output can only be activated if you have allocated a relay switch output to it beforehand in the *Basic Configuration* menu.

#### 25.3.1 Programmable timer

This menu provides 6 freely programmable timer intervals for each switch output.

The timer intervals are displayed in the menu in an easy-to-follow manner with programmed weekdays and times:



The following settings are possible for each of the 6-time intervals:

Sub-menu <i>Timer interval (1..6)</i>	
Weekdays	Selection of one or multiple weekdays on which the timer interval should be active. If no weekday is activated, then the entire timer interval is inactive.
Switch-on time	Time at which switch-on occurs.
Switch-off time	Time at which switch-off occurs
Interval operation	Activation of interval operation (Periodic switching on and off)
Switch-on interval	Switch-on duration for interval operation.
Switch-off interval	Switch-off duration for interval operation.

#### 25.3.2 Basic configuration

The menu *Basic configuration* is used to configure the basic settings for a switch output. This is generally done once upon placing a switch output into operation.

The following settings are available:

Sub-menu <i>Basic configuration</i>	
Relay output	Relay switch output used for the universal switch output.
Block if missing flow	Yes ⇔ Output is turned off if flow signal is missing.
Blocking by filter operation mode	Yes ⇔ The output is turned off depending on the operation mode of the filter pump. Prerequisite: PoolManager® controls the filter pump.
Blocking by input.	Yes ⇔ The output is turned off if the selected input is in the state indicated.
Blocking by another output	Yes ⇔ The output is turned off if the other output selected is in the state indicated.
External switch or push button	See <i>External switch or push-button</i> .



**INFO**

**Terminal block indication**

For the relay outputs OUT1 ... OUT4, the terminal block number is indicated directly in the menu. This is the number in brackets, e.g. [26] for OUT1.



**INFO**

**Switch OUT4**

The relay output OUT4 is designed as a changeover switch. When active (on), terminal block [31] is turned on. When inactive (off), terminal block [32] is turned on. All other switch outputs are designed as simple on / off switches.

### 25.3.2.1 External switch or push-button

Each switch output can be linked with an external switch or push-button, which facilitates turning the function on or off manually.

The following settings can be configured:

Sub-menu <i>External switch or push-button</i>	
External switch	Selection of an input to which the external switch is connected (IN 1 [6] / IN 2 [7] / IN 3 [8] / IN 4 [9] / none)
Type of external switch	<i>On/off switch or push-button</i>
For on/off switch only	
External switch on	Defines the operating mode when external switch is <i>turned on</i> : <ul style="list-style-type: none"> <li>• Output ON</li> <li>• Output AUTO, (Operating mode controlled by PoolManager®)</li> </ul>
External switch off	Defines the operating mode when external switch is <i>turned off</i> : <ul style="list-style-type: none"> <li>• Output OFF</li> <li>• Output AUTO, (Operating mode controlled by PoolManager®)</li> </ul>
For push-buttons only	
External push-button function	<i>Start timer or Output on/off</i>
Timer function switch-on time	Switch-on duration (For the function <i>Start timer</i> )

### 25.3.3 Safety settings



**HAZARD!**

**Hazard via remote access**

Depending on the installation, hazards may be yielded by universal switch outputs, particularly via remote access.

**Potential consequence: Death or the gravest degree of injury, heavy material damage.**

- Release of remote access to universal switch outputs is expressly PROHIBITED for all applications in which the safety of persons, animals, and property is not completely guaranteed at all times and under all circumstances, especially for remote access.
- Safety is exclusively in the system operator's sphere of responsibility.
- The controller manufacturer disclaims all liability.



**HAZARD!**

**Hazard from erroneous operation in Mode menu**

Switch outputs can be switched quickly and easily in Mode menu. This also yields the hazard of an erroneous operation (switching accidentally)

**Potential consequence: Death or the gravest degree of injury, heavy material damage.**

- The display of universal switch outputs in Mode menu is expressly PROHIBITED for all applications in which the safety of persons, animals, and property is not completely guaranteed at all times and under all circumstances, especially in the case of potential erroneous operation in Mode menu.
- Safety is exclusively in the system operator's sphere of responsibility.
- The controller manufacturer disclaims all liability.

The following safety settings are available:

Sub-menu <i>Safety settings</i>	
Allow remote access	Potential settings: <ul style="list-style-type: none"> <li>• Inactive</li> <li>• Local network</li> <li>• Local network &amp; Web</li> </ul>
Show in Mode menu	Yes / no
Display safety notices	Safety notices for a switch output can be deactivated here, if the switched function does not yield any hazards.

### 25.4 Electrical connection



**Required user qualification: ELECTRICAL SPECIALIST**

Electrical connection of universal switch outputs may only be performed by an ELECTRICAL SPECIALIST as defined in the chapter *User qualification*.



**IMPORTANT NOTICE!**

**Do not exceed the maximum currents**

Do not exceed the maximum permissible electrical currents for each individual relay switch output (max. 4 A) and for the sum of all relay switch outputs being used in 230 V~ configuration (in sum, also max. 4 A)

Please also refer to the Chapter *230 V~ Power supply*.

The following figure shows the internal wiring for relay switch outputs OUT1...OUT4, which can be used for universal switch outputs. All connections shown are run internally as conductor paths.

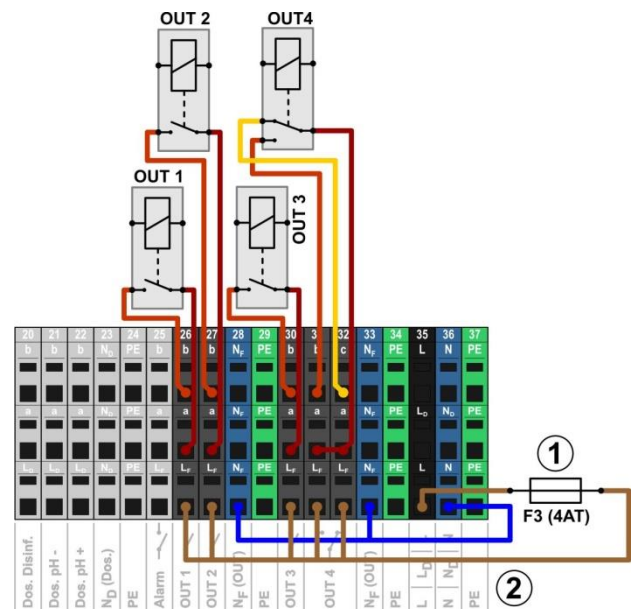

- 1 Fuse 4AT
- 2 230 V~ phase L<sub>F</sub> for the add-on functions (secured with 4 A)

The following terminal blocks are allocated to the relay switch outputs:

Relay switch output	Terminal block	Function
OUT 1	26	On / off switch
OUT 2	27	On / off switch
OUT 3	30	On / off switch
OUT 4	31 and 32	Changeover switch c = Resting contact b = Working contact

Each terminal block is set up as follows:

Terminal	Function
b	Working contact
c	Rest contact (for OUT 4 only)
a	Centre contact
L <sub>F</sub>	Supply phase 230 VAC for add-on functions. Can be bridged to the centre contact if needed in order to control 230 VAC devices.

### 25.4.1 Connection options



**HAZARD!**

**Permissible total current exceeded in 230 V~ applications**

For all 230 V~ switch outputs using PoolManager's® internal 230 V~ supply (bridge from L<sub>F</sub> to centre contact a), the total current must not exceed 4A in total.

The phase L<sub>F</sub> for supplying the add-on functions is secured with 4 AT (F3 OUT).

**Potential consequence:**

**Burning of conductor paths in PoolManager®**

- Ensure that the permissible total current is never exceeded.
- If high currents are needed, then the voltage supply has to be external.
- Please also refer to the Chapter 230 V~ Power supply.



**HAZARD!**

**Exceeding the permissible switching current or the permissible contact voltage**

The electrical current must not exceed 4A per switch output. The maximum permissible switching contact voltages are 230 V~ or 30 V DC.

**Potential consequence:**

**Burning of conductor paths in PoolManager®**

- Ensure that permissible currents and permissible voltages are never exceeded.
- If applicable, secure the electrical circuits externally in accordance with applicable stipulations.
- If higher currents or voltages are needed, then an external electrical power switch has to be used.

#### 25.4.1.1 Control of an external system via 230V~ mains supply

A 230 V~ unit is connected between neutral conductor N (blue) and phase L (brown) of the power supply, between which there is a voltage of 230 V~ (AC voltage). Additionally, there is generally also a protective earth connection (yellow/green).

Should a unit of this kind be controlled via a PoolManager's® universal switch output, then it has to be connected as follows (Example for switch output OUT 1):

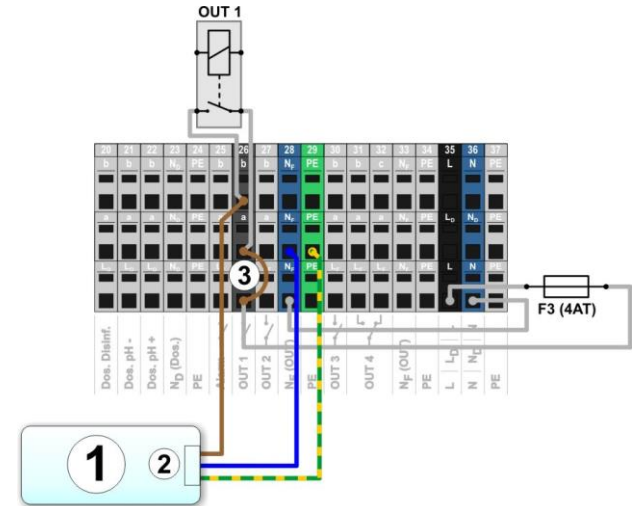

- 1 External system to be controlled
- 2 External system's 230 V~ power supply
- 3 Wire bridge in the terminal box from phase L<sub>F</sub> to centre relay contact a



**INFO**

**Connection of neutral conductor N and PE**

The controlled external system's neutral conductor N and protective earth PE can be connected to the N<sub>F</sub> and PE terminal blocks as shown in the figure.

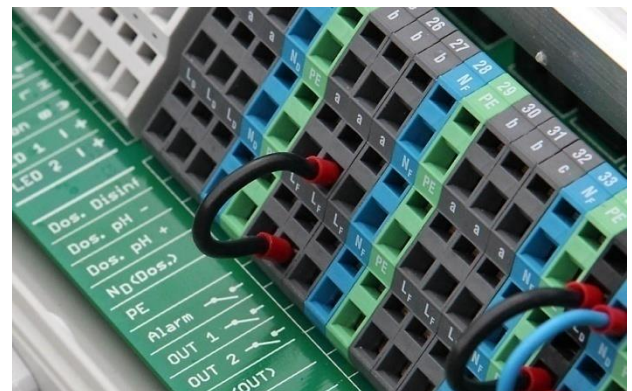

Wire bridge in the terminal box from phase L<sub>F</sub> to centre relay contact a



### 25.4.1.2 Control of an external system with a volt-free control input

Some systems have a volt-free control input. This can be connected directly to a PoolManager's® switch output.

If a control input of this kind is available, then it should be used whenever possible instead of turning the external system's power supply on and off.

The following figure shows the connection of an external system with volt-free control input to the switch output OUT 1:

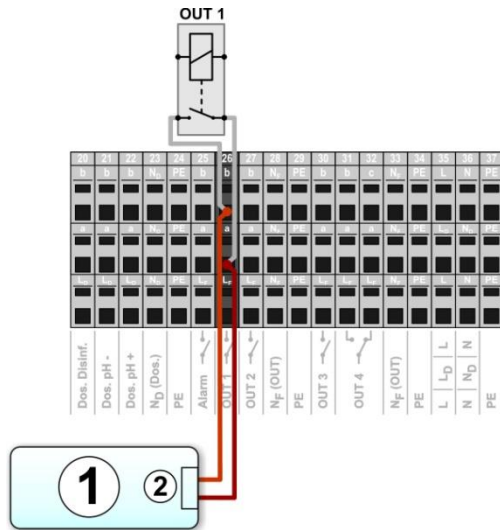

- 1 External system to be controlled
- 2 External system's volt-free control input

### 25.4.1.3 Control of an external system with external power supply

For external systems with their own power supply (AC or DC), the power supply can be turned on and off via a PoolManager's® switch output.

The following figure schematically shows an application example for switch output OUT 1.

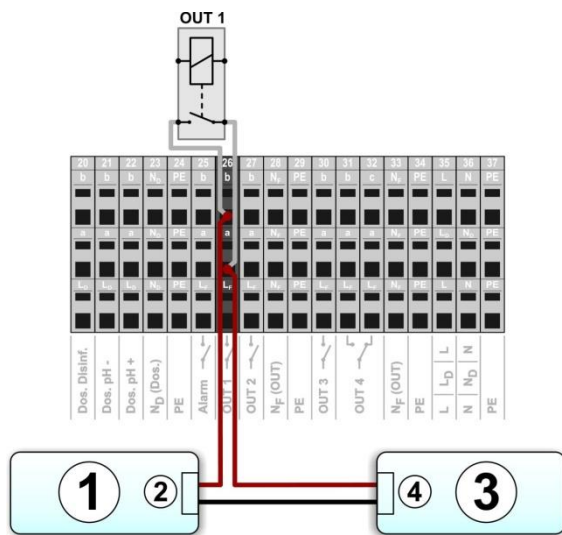

- 1 External system to be controlled
- 2 External system's voltage supply input
- 3 External system's voltage supply (AC or DC)
- 4 External system's voltage supply output

### 25.4.2 Lifespan of relay switching contacts

Depending on application, the lifespan of a relay switching contact may be limited.

In general, the lifespan of a relay contact is reduced by high switching currents.

The following guideline values can be used for orientation:

- 230 V~, 0.5 A, resistive load  
⇒ Lifespan > 1,000,000 switches
- 230 V~, 4 A, resistive load  
⇒ Lifespan > 300,000 switches

## 26 Filter pump control

### 26.1 Safety information



**Required user qualification:**  
**TRAINED SPECIALIST or ELECTRICAL SPECIALIST**

Connection, configuration, and start-up of filter pump control may only be performed by a **TRAINED SPECIALIST**, or an **ELECTRICAL SPECIALIST** as defined in the chapter *User qualification*.



**HAZARD!**

**Hazard from turning on filter pump**

Turning on a filter pump can yield hazards for bathers (e.g., due to current or suction effects).

**Potential consequence: Death or the gravest degree of injury, heavy material damage.**

- Turning on a filter pump is expressly **PROHIBITED** for all applications in which the safety of persons, animals, and property is not completely guaranteed at all times and under all circumstances.
- Safety is exclusively in the system operator's sphere of responsibility.
- The controller manufacturer disclaims all liability.

### 26.2 Overview

PoolManager® offers a control option for filter pumps. Conventional filter pumps are simply turned on and off. Suitable variable filter pumps can additionally be set into three different operating modes:

- Normal mode  
(Normal filter operation)
- Eco mode  
(Energy saving mode with reduced pump output, e.g., for night reduction)
- Increased mode  
(Increase pump output, e.g., for filter rinsing, connecting water attractions, or solar operation)

PoolManager® filter pump control additionally offers the following options:

- Multiple flexibly programmable timers
- Freely configurable blocking of dosing (pH and disinfection) depending on the filter pump operating mode
- Linking of each filter pump operating mode with an external switch or push-button
- Flexible allocation of up to three relay switch outputs for the filter pump's various operating modes
- Operation of relay switch outputs optionally as potential free switch or as 230 V~-output
- Alternative filter pump control via a 4-20 mA current loop output (optional)

### 26.3 Menu Filter pump

The configuration menu for filter pump control is called up with the following icon:



Filter pump

The following settings are available:

<b>Menu Filter pump</b>
<b>Filter pump mode of operation</b>
Selection of operating mode: <ul style="list-style-type: none"> <li>• Inactive (Filter pump control not used)</li> <li>• Filter pump off</li> <li>• Normal mode</li> <li>• Eco mode</li> <li>• Increased mode</li> <li>• Timer</li> </ul>
<b>Programmable timer</b>
Programming timers.
<b>Basic configuration</b>
Basic settings for filter pump control.
<b>Dosing settings</b>
Settings to enable or block dosing in the different operating modes of the filter pump
<b>Safety settings</b>
Safety settings for filter pump control.



**INFO**

**Allocation of relay switch outputs**

An operating mode can only be activated if you have allocated a relay switch output to it beforehand in the *Basic Configuration* menu.

#### 26.3.1 Programmable timer

This menu provides 6 freely programmable timer intervals for filter pump control.

The timer intervals are displayed in the menu in an easy-to-follow manner with programmed weekdays and times and with the filter pump's operating mode:



The following settings are possible for each of the 6 timer intervals:

Sub-menu <i>Timer interval (1..6)</i>	
Filter pump mode	The desired operating mode for this time interval: <ul style="list-style-type: none"> <li>• Normal mode</li> <li>• Eco mode</li> <li>• Increased mode</li> </ul>
Days of the Week	Selection of one or multiple weekdays on which the timer interval should be active. If no weekday is activated, then the entire timer interval is inactive.
Switch-on time	Time at which switch-on occurs.
Switch-off time	Time at which switch-off occurs

#### 26.3.2 Basic configuration

The menu *Basic configuration* is used to configure the basic settings for a switch output. This is generally done only once during commissioning.

The following settings are available:

Sub-menu <i>Basic configuration</i>	
Filter pump control interface	<i>Relay control or 4-20 mA current output</i>
External switches	See <i>External switches</i> .
For Relay control only	
Allocation of inputs and outputs	See <i>Allocation of inputs and outputs</i> .
Only for 4-20 mA current output	
Configuration 4-20mA current output	See <i>Configuration 4-20 mA current output</i>

##### 26.3.2.1 Allocation of inputs and outputs

**For Relay control only:**

This menu allocates the relay switch outputs for filter pump control.

Sub-menu <i>Allocation of inputs and outputs</i>	
Relay output 'Filter pump on/off'	Relay switch output for turning on the filter pump (for conventional filter pumps or as main on/off switch for variable filter pumps).
Relay output 'Normal mode'	Relay switch outputs for activating the various operating modes for variable filter pumps. Note: Not all three operating modes have to be used.
Relay output 'Eco mode'	
Relay output 'Increased mode'	

For each relay switch output, the following settings are available:

Setting	Description
None	The corresponding function is not used.
OUT 1 [26]	Relay switch output OUT 1 [terminal block 26]
OUT 2 [27]	Relay switch output OUT 2 [terminal block 27]
OUT 3 [30]	Relay switch output OUT 3 [terminal block 30]
OUT 4 [31]	Relay switch output OUT 4 [terminal block 31]
pH+ [22]	Dosing relay pH + [terminal block 22] Can only be used if no pH+ dosage is used.
pH- [21]	Dosing relay pH - [terminal block 21] Can only be used if no pH- dosage is used.
Alarm [25]	Alarm relay [terminal block 25] Can only be used, if the alarm relay function has been deactivated in the <i>Alarm Settings</i> menu (Use <i>alarm relay = No</i> ).

### 26.3.2.2 Configuration 4-20 mA current output

**Only for control with 4-20 mA current output:**

This menu configures the 4-20 mA current output for the filter pump control.



**INFO**

**Plug-in module PM5-SA4 needed**

To trigger the filter pump via a 4-20 mA current output, the following optional plug-in module is needed:  
PM5-SA4 CONVERTER 4-20MA (Art. no. 127011)

Configuration power output 4-20 mA	
Relay output 'Filter pump on/off'	Relay switch output for turning on the filter pump (for conventional filter pumps or as superordinate on/off switch for variable filter pumps).
Power output used	Power output for triggering the filter pump.
Power for pump off	Entry of currents in [mA], which the power output used sets for the various operating modes.
Power for reduced output	
Power for normal operation	
Power for increased output	

### 26.3.2.3 External switches

The filter pump control can be linked with up to three external switches or push-buttons that facilitate switching on or off manually or activating a certain operating mode.

The following settings can be configured:

Sub-menus <i>External switch 1 / 2 / 3</i>	
External switch 1 / 2 / 3	Selection of an input to which the external switch is connected (IN 1 [6] / IN 2 [7] / IN 3 [8] / IN 4 [9] / none)
Type of external switch	On/off switch or push-button.
For on/off switch only	
External switch on	Defines the operating mode when external switch is <i>turned on</i> : <ul style="list-style-type: none"> <li>Filter pump off</li> <li>Normal mode / eco mode / increased mode</li> <li>Filter pump AUTO, (Operating mode controlled by PoolManager®)</li> </ul>
External switch off	Defines the operating mode when external switch is <i>turned off</i> : <ul style="list-style-type: none"> <li>Filter pump off</li> <li>Normal mode / eco mode / increased mode</li> <li>Filter pump AUTO, (Operating mode controlled by PoolManager®)</li> </ul>
For push-button only	
Function of external push-button	Switch off / normal / off / ... or switch off / low / normal / high / off / ...

### 26.3.2.4 Dosing Settings

Here, you can define the operating modes in which dosing is blocked for pH control and disinfection.

Sub-menu <i>Dosing Settings</i>	
Dosing in increased mode	On / off Standard = off
Dosing in eco mode	On / off Standard = off



**HAZARD!**

**Gaseous chlorine produced from dosing with too little water circulation**

When dosing in water with very little circulation, poisonous gaseous chlorine can be produced when sodium hypochlorite and pH-Minus meet.

**Potential consequence: Death or the gravest degree of injury, heavy material damage.**

- Only activate dosing in eco mode if good circulation and quick transportation of the dosed maintenance produced are secured.
- In cases of doubt, block dosing for reduced output.



**INFO**

**Dosing for increased output**

pH and redox measurements are generally barely affected by flow. Therefore, it is not absolutely necessary to block dosing in increased mode.

For maximum safety, however, blocking is recommended.

Direct measurement of free chlorine or bromine is flow dependent to a certain level. Therefore, it is recommended to disable dosing in increased mode for the PoolManager® PRO.

### 26.3.3 Safety settings



**HAZARD!**

**Hazard via remote access to filter pump control**

Turning on a filter pump in remote access can yield hazards for bathers (e.g., due to current or suction effects).

**Potential consequence: Death or the gravest degree of injury, heavy material damage.**

- Remote access to filter pump control is expressly PROHIBITED for all applications in which the safety of persons, animals, and property is not completely guaranteed at all times and under all circumstances, and in particular in case of remote access.
- Safety is exclusively in the system operator's sphere of responsibility.
- The controller manufacturer disclaims all liability.

The following safety settings are available:

Sub-menu <i>Safety settings</i>	
Allow filter pump remote access	Potential settings: <ul style="list-style-type: none"> <li>Inactive</li> <li>Local network</li> <li>Local network &amp; Web</li> </ul>
Show in Mode menu	Yes / no

26.4 Electrical connection



**Required user qualification:**  
**ELECTRICAL SPECIALIST**

Electrical connection of filter pump control may only be performed by an ELECTRICAL SPECIALIST as defined in the chapter *User qualification*.



**IMPORTANT NOTICE!**

**Do not exceed the maximum currents**

Do not exceed the maximum permissible electrical currents for each individual relay switch output (max. 4 A) and for the sum of all relay switch outputs being used in 230 V~ configuration (in sum, also max. 4 A)

Please also refer to the Chapter 230 V~ Power supply.

The connection options already described for universal switch outputs can be used for connecting a conventional filter pump; see *Universal switch outputs* → *connection options*.

The connection of a variable filter pump is shown schematically in the following figure.

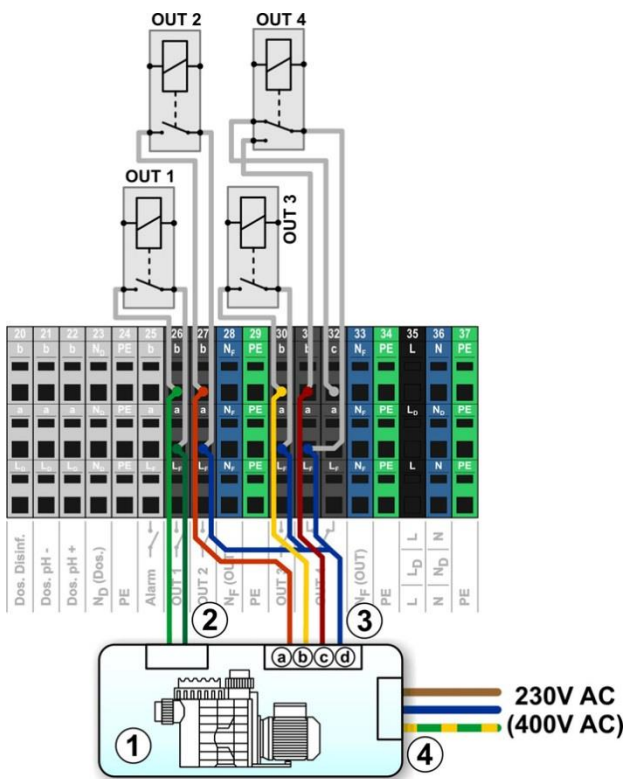

- 1 Filter pump
- 2 Volt-free control input for on / off (optional)
- 3 Volt-free control inputs to select the operating mode
- 3a Volt-free control input for normal mode
- 3b Volt-free control input for eco mode
- 3c Volt-free control input for increased mode
- 3d Joint contact for all volt-free control inputs
- 4 External power supply for the filter pump 230 V~ (or 400 V~)

The following *Allocation of inputs and outputs* is required in the menu for the connection schematic shown in this figure:

Function	Relay switch output
Relay output 'Filter pump on/off'	OUT 1 [26]
Relay output 'normal mode'	OUT 2 [27]
Relay output 'eco mode'	OUT 3 [30]
Relay output 'increased mode'	OUT 4 [31]

27 Flockmatic® pump

27.1 Safety information



**Required user qualification:**  
**TRAINED SPECIALIST or ELECTRICAL SPECIALIST**

Connection, configuration, and start-up of Flockmatic® pump control may only be performed by a TRAINED SPECIALIST, or an ELECTRICAL SPECIALIST as defined in the chapter *User qualification*.

27.2 Overview

PoolManager® offers the option of connecting and controlling a Flockmatic® pump.

PoolManager® Flockmatic® control additionally offers the following options:

- Reducing Flockmatic® dosing rate
- Blocking flock dosing in the event of missing flow
- Multiple flexibly programmable timers
- Optional level monitoring via a switch input

27.3 Menu Flockmatic® pump

The configuration menu for Flockmatic® control is called up with the following icon:



Flockmatic® pump

The following settings are available:

<b>Menu Flockmatic® pump</b>
<b>Flockmatic® mode of operation</b>
Selection of operating mode: <ul style="list-style-type: none"> <li>• Inactive (Flockmatic® control not used)</li> <li>• Off (Flockmatic® used, but turned off)</li> <li>• On</li> <li>• Timer</li> </ul>
<b>Programmable timer</b>
Programming timers.
<b>Basic configuration</b>
Basic settings for Flockmatic® control.



**INFO**

**Allocation of a relay switch output**

Flockmatic® control can only be activated if you have allocated a relay switch output to it beforehand in the *Basic configuration* menu.



### 27.3.1 Programmable timer

This menu provides 3 freely programmable timer intervals for Flockmatic® control.

Programming here is identical to programming the timers for the universal switch outputs, see *Universal switch outputs* → *Programmable timer*.

### 27.3.2 Basic configuration

The menu *Basic configuration* is used to configure the basic settings for Flockmatic® control. This is generally done once during commissioning.

The following settings are available:

Sub-menu <i>Basic configuration</i>	
Flockmatic® relay output	The relay switch output used for Flockmatic® control. (None / OUT 1 [26] / OUT 2 [27] / OUT 3 [30] / OUT 4 [31] / pH+ [22] / pH- [21] / Alarm [25]). None ⇒ Flockmatic® control is inactive
Flockmatic® dosing rate	Desired Flockmatic® dosing output in [%]: <ul style="list-style-type: none"> <li>• 100 % ⇒ Flockmatic® pump runs non-stop</li> <li>• &lt;100 % ⇒ Cyclic turning on and off</li> </ul>
Level input Flockmatic®	Allocation of an input for level monitoring of flock canister (optional) (IN 1 [6] / IN 2 [7] / IN 3 [8] / IN 4 [9] / none).

### 27.4 Electrical connection



**Required user qualification:**  
**ELECTRICAL SPECIALIST**

Electrical connection of filter pump control may only be performed by an ELECTRICAL SPECIALIST as defined in the chapter *User qualification*.



**IMPORTANT NOTICE!**

**Do not exceed the maximum currents**

Observe the maximum permissible electrical current for the sum of all relay switch outputs being used in 230 V~ configuration (in sum, max. 4 A).

Please also refer to the Chapter *230 V~ Power supply*.

The following figure schematically shows the connection of a Flockmatic® pump to relay switch output OUT1.

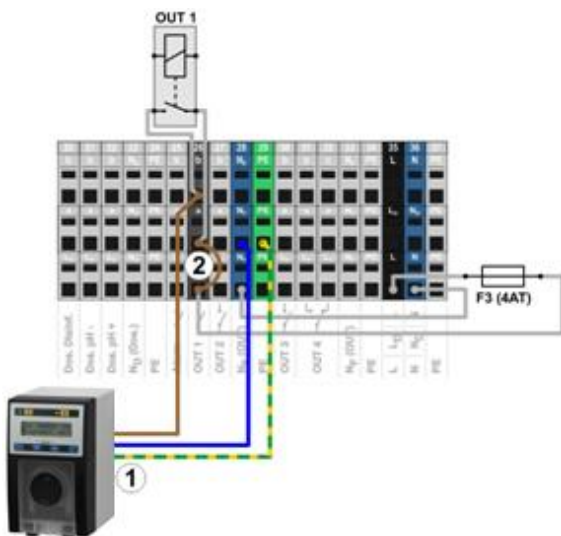

- 1 Flockmatic® pump with power supply 230 V~
- 2 Wire bridge in the terminal box from phase L<sub>F</sub> to centre relay contact a



**INFO**

**Connection of neutral conductor N and PE**

A Flockmatic® pump's neutral conductor N and protective earth PE can be connected to the N<sub>F</sub> and PE terminal blocks as shown in the figure.

## 28 Heating

### 28.1 Overview

PoolManager® offers the option to control a heating system.

The heating system is controlled via a simple relay switch output (volt-free or 230 V~). The exact type and design of the heating system is not important. There only needs to be a possibility to turn the heating function on and off externally via a corresponding input (either volt-free or 230 V~).



**INFO**

**Changeover switch OUT 4 [31/32]**

If you need a changeover switch for heating control, you can use the relay switch output OUT 4:

- [31b] Working contact
- [32c] Rest contact

### 28.2 Temperature measurement

Heating control requires measurement of the water temperature. PoolManager's® three temperature inputs can be used to do so.

You'll find a detailed description in the chapter *Temperature measurement*. This chapter also lists the sensor types supported by PoolManager®.



**IMPORTANT NOTICE!**

**Measurement precision of the standard temperature sensor in the measurement chamber**

The standard temperature sensor in PoolManager® measuring cell can fundamentally be used for temperature measurement. It represents a very simple solution, as there is no need for additional installation work.

However, note that the temperature measured in the measuring cell may deviate from the actual pool temperature. Through changes in air temperature, sunshine, or other influences, the water may heat up or cool down along its path through the measuring water circuit.

Calibration cannot fully compensate for these effects, which fluctuate over time.

For this reason, the measurement precision to be expected of the standard temperature sensor is generally too low for reliable temperature measurement and control.

For controlling the heating system, you should therefore definitely install an additional sensor directly in the main circulation circuit. The sensor's measurement signal needs to be independent of external effects and representative for the pool temperature.

### 28.3 Function

The desired temperature setpoint and switch hysteresis can be configured as parameters.

The setpoint temperature is configurable in a range between 10.0 °C and 40.0 °C.

Hysteresis ensures that heating control does not turn on and off for marginal temperature changes, rather only when there is a certain deviation from the setpoint.

Hysteresis is configurable in a range between 0.1 °C and 5.0 °C.

The temperature setpoint and the temperature hysteresis yield the temperatures at which heating control turns on and off as follows:

Turn-on temperature	Temperature setpoint minus half of hysteresis
Turn-off temperature	Temperature setpoint plus half of hysteresis

#### Example 1

- Temperature setpoint 25.0 °C
- Temperature hysteresis 1.0 °C
- ⇒ Turn-on temperature 24.5 °C
- ⇒ Turn-off temperature 25.5 °C

#### Example 2

- Temperature setpoint 25.0°C
- Temperature hysteresis 0.3°C
- ⇒ Turn-on temperature 24.9°C (value rounded)
- ⇒ Turn-off temperature 25.2°C (value rounded)

The hysteresis setting can be used to optimally adjust the control system to the local circumstances.

### 28.4 Show in home view

The operating state of the heating system or solar heating system is displayed in "Home" view in the temperature module.

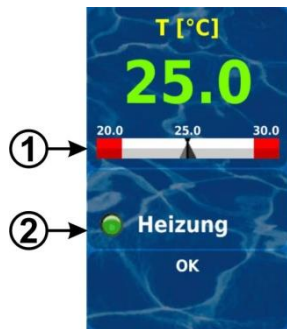

Pos.	Content	Notes
1	Temperature setpoint	Display of temperature setpoint on the measured value scale
2	Status of heating and/or solar heating	Status display of <i>heating or solar heating</i> . When heating is on, the LED symbol illuminates.

### 28.5 Menu Heating

The configuration menu for heating control is called up with the following icon:



The following settings are available:

Menu Heating	
Heating mode of operation	<ul style="list-style-type: none"> <li>• Inactive (heating control not used)</li> <li>• Heating off (heating control used, but turned off)</li> <li>• Always heat (regardless of temperature!)</li> <li>• Auto (automatic temperature control)</li> </ul>
Temperature setpoint	Desired pool temperature in [°C]
Temperature hysteresis	Permissible tolerance range for temperature control in [°C]
Basic configuration	
Basic settings for heating control.	
Safety settings	
Safety settings for heating control.	



#### INFO

##### Allocation of a relay switch output

Heating control can only be activated if you have allocated a relay switch output to it beforehand in the *Basic configuration* menu.

#### 28.5.1 Basic configuration

The menu *Basic configuration* is used to configure the basic settings for heating control. This is generally done once at the start-up.

The following settings are available:

Sub-menu Basic configuration	
Pool temperature input	Temperature input used for measuring pool temperature: <ul style="list-style-type: none"> <li>• Inactive (function not used)</li> <li>• Temp. input 1 [3]</li> <li>• Temp. input 2 [4]</li> <li>• Temp. input 3 [5]</li> </ul>
Relay output 'Heating'	Relay switch output used for activating heating (None / OUT 1 [26] / OUT 2 [27] / OUT 3 [30] / OUT 4 [31] / pH+ [22] / pH- [21] / Alarm [25]). None ⇒ Heating control is inactive
Block if solar heating is active	Yes / no Yes ⇒ Heating is not turned on when solar heating is active (solar priority).
Blocking by input.	If an input is selected for this function, then the heating output is turned off if the selected input is in the state indicated.
Frost protection	See <i>Frost protection</i> .
Temperature sensor configuration	Configure types and functions of temperature sensors.

### 28.5.1.1 Frost protection

The menu Frost protection can be used to activate a frost protection function for heating control.

Sub-menu <i>Frost protection</i>	
Ambient temperature input	The temperature input used for measuring air temperature (optional for frost protection): <ul style="list-style-type: none"> <li>• Inactive (function not used)</li> <li>• Temp. input 1 [3]</li> <li>• Temp. input 2 [4]</li> <li>• Temp. input 3 [5]</li> </ul>
st protection temperature	Frost protection is activated, if the measured ambient temperature drops below the given threshold.
Temperature sensor configuration	Configure types and functions of temperature sensors.

### 28.5.2 Safety settings



#### HAZARD!

#### Hazard via remote access

In some circumstances, hazards may be yielded via remote access to the heating control system, e.g. scalding.

#### Potential consequence: Injury, material damage.

- Release of remote access to heating control is expressly PROHIBITED for all applications in which the safety of persons, animals, and property is not completely guaranteed at all times and under all circumstances, especially for remote access.
- Safety is exclusively in the system operator's sphere of responsibility.
- The controller manufacturer disclaims all liability.

The following safety settings are available:

Sub-menu <i>Safety settings</i>	
Allow remote access	Potential settings: <ul style="list-style-type: none"> <li>• Inactive</li> <li>• Local network</li> <li>• Local network &amp; Web</li> </ul>
Show in Mode menu	Yes / no

### 28.6 Electrical connection



#### Required user qualification:

#### ELECTRICAL SPECIALIST

Electrical connection of heating system control may only be performed by an ELECTRICAL SPECIALIST as defined in the chapter *User qualification*.



#### IMPORTANT NOTICE!

#### Do not exceed the maximum currents

Do not exceed the maximum permissible electrical currents for each individual relay switch output (max. 4 A) and for the sum of all relay switch outputs being used in 230 V~ configuration (in sum, also max. 4 A)

Please also refer to the Chapter *230 V~ Power supply*.

Depending on the type and model of the heating system, there are various options for establishing the electrical connection (volt-free, 230 V~,...).

In general, the connection options already described for the universal switch outputs are available, see *Universal switch output* → *connection options*.

## 29 Solar heating

### 29.1 Overview

PoolManager® offers the option to control a solar heating system.

The solar heating system is controlled via a simple relay switch output (volt-free or 230 V~). The exact type and design of the solar heating system is not important. There only needs to be the possibility to turn the solar heating function on and off externally via a corresponding input (either volt-free or 230 V~).



#### INFO

#### Changeover switch OUT 4 [31/32]

If you need a changeover switch for solar control, you can use the relay switch output OUT 4:

- [31b] Working contact
- [32c] Rest contact

### 29.2 Temperature measurement

Solar control requires measurement of the water temperature. For more information, see *Heating* → *Temperature measurement*.

Measurement of solar temperature is also required. Another one of the PoolManager's® three temperature inputs can be used to connect a solar sensor.

You'll find a detailed description in the chapter *Temperature measurement*. This chapter also lists all temperature sensor types supported by PoolManager®.

### 29.3 Function

The function of solar control is based on conventional heating control. For more information, see *Heating* → *Function*.

As an additional parameter, the required minimum temperature difference between solar temperature and pool temperature can be entered. The solar control system will only be activated, if the difference between solar temperature and pool temperature is higher than the value indicated.

### 29.4 Show in "Home" view

The operating state of the heating system or solar heating system is displayed in home view in the temperature module.

For more information, see *Heating* → *Show in home view*.

### 29.5 Menu Solar heating

The configuration menu for solar control is called up with the following icon:



Solar heating

The following settings are available:

Menu Solar heating	
Solar Heating Mode of Operating	<ul style="list-style-type: none"> <li>• Inactive (solar control not used)</li> <li>• Solar off (solar control used, but turned off)</li> <li>• Solar always on (regardless of temperature!)</li> <li>• Auto (automatic temperature control)</li> </ul>
Pool Temperature setpoint (Solar)	Desired pool temperature in [°C]
Temperature hysteresis (Solar)	Permissible tolerance range for temperature control in [°C]
Min. difference solar → pool	Requisite temperature difference between solar temperature and pool temperature to activate the solar heating.
Basic configuration	
Basic settings for solar control.	
Safety settings	
Safety settings for solar control.	



**INFO**

**Allocation of a relay switch output**

Solar control can only be activated if you have allocated a relay switch output to it beforehand in the *Basic configuration* menu.

#### 29.5.1 Basic configuration

The menu *Basic configuration* is used to configure the basic settings for solar control. This is generally done once at commissioning.

The following settings are available:

Sub-menu Basic configuration	
Pool temperature input	The temperature inputs used for measuring pool temperature and for solar temperature:
Solar temperature input	<ul style="list-style-type: none"> <li>• Inactive (function not used)</li> <li>• Temp. input 1 [3]</li> <li>• Temp. input 2 [4]</li> <li>• Temp. input 3 [5]</li> </ul>
Relay output 'heating'	Relay switch output used for activating heating (None / OUT 1 [26] / OUT 2 [27] / OUT 3 [30] / OUT 4 [31] / pH+ [22] / pH- [21] / alarm [25]). None ⇔ Solar control is inactive
Cooling function	Cooling through the solar system can be enabled here.
Blocking by input.	If an input is selected for this function, then the heating output is turned off if the selected input is in the state indicated.
Frost protection	See <i>Frost protection</i> .
Temperature sensor configuration	Configure types and functions of temperature sensors.

##### 29.5.1.1 Frost protection

The frost protection function has already been described for heating control.

For more information, see *Heating* → *Frost protection*.

### 29.5.2 Safety settings



**HAZARD!**

**Hazard via remote access**

In some circumstances, hazards may be yielded via remote access to the solar control system, e.g., scalding.

**Potential consequence: Injury, material damage.**

- Release of remote access to solar control is expressly PROHIBITED for all applications in which the safety of persons, animals, and property is not completely guaranteed at all times and under all circumstances, especially for remote access.
- Safety is exclusively in the system operator's sphere of responsibility.
- The controller manufacturer disclaims all liability.

The following safety settings are available:

Sub-menu Safety settings	
Allow remote access	Potential settings: <ul style="list-style-type: none"> <li>• Inactive</li> <li>• Local network</li> <li>• Local network &amp; Web</li> </ul>
Show in Mode menu	Yes / no

### 29.6 Electrical connection



**Required user qualification:**

**ELECTRICAL SPECIALIST**

Electrical connection of the solar control system may only be performed by an ELECTRICAL SPECIALIST as defined in the chapter *User qualification*.



**IMPORTANT NOTICE!**

**Do not exceed the maximum currents**

Do not exceed the maximum permissible electrical currents for each individual relay switch output (max. 4 A) and for the sum of all relay switch outputs being used in 230 V~ configuration (in sum, also max. 4 A)

Please also refer to the Chapter *230 V~ Power supply*.

Depending on the type and model of the solar heating system, there are various options for establishing the electrical connection (voltage-free, 230 V~, ...).

In general, the connection options already described for the universal switch outputs are available, see *Universal switch output* → *connection options*.



### 30 Eco mode (energy saving mode)

The function eco mode (energy saving mode) facilitates automatic, timed switch of the pool from normal mode into an energy-saving operating mode. The two operating modes are designated as follows:

- Normal mode (normal pool operation)
- Eco mode (energy-saving operation)

Actual execution of the two operating modes can be realised in a very flexible manner.

#### Example (for pools with an overflow):

- Normal mode ⇒ Circulation via the overflow
- Eco mode ⇒ Circulation via the floor drain (reduction of thermal loss)

The function eco mode provides the following options:

- Multiple flexibly programmable timers
- Flexible allocation of relay switch outputs for the two operating modes
- Operation of relay switch outputs optionally as volt-free switches or as 230 V~-outputs
- Link with an external switch or push-button for switching the operating mode

The two relay outputs for this function are connected as follows for the respective operating mode:

Operating mode	Status of the allocated relay switch outputs	
Normal operation	Relay output 'normal mode'	On
	Relay output 'eco mode'	Off
Eco mode (Energy saving mode)	Relay output 'normal mode'	Off
	Relay output 'eco mode'	On

#### 30.1 Menu Eco mode

The configuration menu for *Eco mode* is called up with the following icon:



Eco mode

The following settings are available:

Menu Eco mode	
Operating mode	<ul style="list-style-type: none"> <li>• Inactive (Eco mode not used)</li> <li>• Normal mode</li> <li>• Eco mode</li> <li>• Timer (Automatically timed switching between operating modes)</li> </ul>
Programmable timer	
Programming timers.	
Basic configuration	
Basic settings for the Eco mode.	
Safety settings	
Safety settings for the Eco mode.	



#### INFO

##### Allocation of a relay switch output

Eco mode can only be activated if you have allocated a relay switch output to it beforehand in the *Basic configuration* menu.

#### 30.1.1 Programmable timer

This menu provides 6 programmable timer intervals for eco mode.

Eco mode is activated during the programmed times; normal mode is activated outside of the programmed times.

Programming here is identical to programming the timers for the universal switch outputs, see *Universal switch outputs*, → *Programmable timer*.

#### 30.1.2 Basic configuration

The menu *Basic configuration* is used to configure the basic settings for eco mode. This is generally done once at commissioning.

The following settings are available:

Sub-menu Basic configuration	
Relay output 'Normal mode'	Relay switch outputs used for both operating modes <i>Normal mode</i> and <i>Eco mode</i>
Relay output 'Eco mode'	(None / OUT 1 [26] / OUT 2 [27] / OUT 3 [30] / OUT 4 [31] / pH+ [22] / pH- [21] / Alarm [25]). In order to activate the Eco mode, it is sufficient to allocate at least one of the two relay outputs.
External switch or push-button	See <i>External switch or push-button</i> .

##### 30.1.2.1 External switch or push-button

The eco mode function can be linked with an external switch or push-button, which facilitates turning the function on or off manually.

The following settings can be configured:

Sub-menu External switch or push-button	
External switch	Selection of an input to which the external switch is connected (IN 1 [6] / IN 2 [7] / IN 3 [8] / IN 4 [9] / none)
Type of external switch	<i>On/off switch or push-button</i>
For on/off switch only	
External switch on	Defines the operating mode when external switch is <i>turned on</i> : <ul style="list-style-type: none"> <li>• Eco mode</li> <li>• Normal mode</li> <li>• Automatic mode (Operating mode controlled by PoolManager®)</li> </ul>
External switch off	Defines the operating mode when external switch is <i>turned off</i> : <ul style="list-style-type: none"> <li>• Eco mode</li> <li>• Normal mode</li> <li>• Automatic mode (Operating mode controlled by PoolManager®)</li> </ul>
For push-button only	
External push-button function	Switch <i>eco mode / normal mode / eco mode / ...</i> (fixed setting, cannot be changed)

30.1.3 Safety settings



**HAZARD!**

**Hazard via remote access**

Depending on the form of realisation, hazards may be created from remote access to the eco mode function.

**Potential consequence: Injury, material damage.**

- Release of remote access to the eco mode function is expressly PROHIBITED for all applications in which the safety of persons, animals, and property is not completely guaranteed at all times and under all circumstances, especially for remote access.
- Safety is exclusively in the system operator's sphere of responsibility.
- The controller manufacturer disclaims all liability.

The following safety settings are available:

Sub-menu <i>Safety settings</i>	
Allow remote access	Potential settings: <ul style="list-style-type: none"> <li>• Inactive</li> <li>• Local network</li> <li>• Local network &amp; Web</li> </ul>
Show in Mode menu	Yes / no

30.2 Electrical connection



**Required user qualification: ELECTRICAL SPECIALIST**

The electrical connection for eco mode may only be performed by an ELECTRICAL SPECIALIST as defined in the chapter *User qualification*.



**IMPORTANT NOTICE!**

**Do not exceed the maximum currents**

Do not exceed the maximum permissible electrical currents for each individual relay switch output (max. 4 A) and for the sum of all relay switch outputs being used in 230 V~ configuration (in sum, also max. 4 A)

Please also refer to the Chapter *230 V~ Power supply*.

Depending on how eco mode is realised, there are various options for establishing the electrical connection (volt-free, 230 V~,...).

In general, the connection options already described for the universal switch outputs are available, see *Universal switch outputs → connection options*.

31 Universal switch inputs IN 1 ... IN 4

PoolManager® provides four universal switch inputs that can be connected to external volt-free switches or switch contacts:

Universal switch input	Description
IN 1 [6]	Switch input IN 1 [terminal block 6]
IN 2 [7]	Switch input IN 2 [terminal block 7]
IN 3 [8]	Switch input IN 3 [terminal block 8]
IN 4 [9]	Switch input IN 4 [terminal block 9]

Several of the potential applications are described in connection with the various add-on functions, e.g. connection of an external switch or push-button.



**IMPORTANT NOTICE!**

**Volt-free inputs**

The externally connected switch or switch contact absolutely must be volt-free (free of electrical potential). Otherwise, residual currents may arise, which can, among other things, destroy electronic components.

The following figure shows the internal wiring of the input IN 1. The other inputs IN 2 ... IN 4 are set up identically.

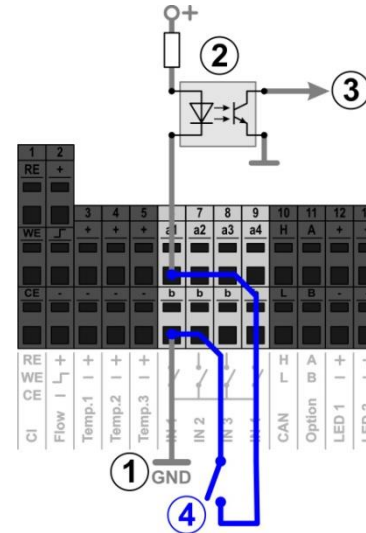

- 1 Internal ground connection of terminal b (The b terminals on all four switch inputs are internally linked to ground)
- 2 Internal optical coupler for galvanic isolation
- 3 Signal output for internal processing
- 4 Externally connected volt-free switch

32 Hardware resources (inputs and outputs)

The simultaneous use of numerous add-on functions is limited by the hardware resources available. This includes the following inputs and outputs:

- Relay switch outputs OUT 1 ... OUT 4
- Universal switch inputs IN 1 ... IN 4
- Temperature inputs Temp.1 ... Temp.3
- Current outputs (optional plug-module PM5-SA4)

Add-on functions can only be activated if the requisite hardware resources are still available.



**INFO**

**Add-on box (feature box)**

An external add-on box (feature box) with supplemental inputs and outputs is in development to overcome these limitations.

The menu *Add-on functions* shows the resources that are already being used:



In the example shown, the following resources are used:

Add-on function	utilised resources
Universal switch output 1 "Waterfall"	Relay switch output OUT 1 Switch input IN 1
Universal switch output 2 "Underwater lights"	Relay switch output OUT 2 Switch input IN 2
Filter pump	Relay switch output OUT 3 Relay switch output OUT 4
Flockmatic® pump	Relay switch output pH+ (This output can only be used if no pH-Plus dosing is being used)

When inputs and outputs are allocated to a certain function, these resources are deactivated (greyed) in the corresponding selection menus.

They are shown in grey lettering and cannot be selected. The previous function may have to be deactivated first. The following figure shows an example:



- 1 Current selection (white background)
- 2 Additional selection options (free resources, white lettering)
- 3 Deactivated selection options (resources already being used, grey lettering)
- 4 Selection "none"  
The corresponding function is no longer linked with a resource and therefore cannot be activated. The corresponding resources are available for other functions.

## Part C: Installation, start-up, maintenance



**Required user qualification:**  
**TRAINED SPECIALIST**

All activities described in Part C may only be performed by TRAINED SPECIALISTS as defined in the Chapter *User Qualification*.

### 33 Safety information for performing installation, start-up, and maintenance work



**HAZARD!**  
**Hazard from electrical current**

PoolManager® begins to run as soon as there is voltage on the incoming power line. It is possible that dosing pumps start or that add-on functions are turned on or switched. Contact with current-carrying components can lead to an electrical shock.

**Potential consequence: Grave health hazard and death, material damage**

- Installation and maintenance work on the unit must always be performed in the volt-free state.
- The unit must be secured against turning on while performing work!
- Supplemental component groups have to be mounted / dismantled in the volt-free state.
- Cables also have to be connected in a volt-free state.
- There should always be safety equipment present that is independent of the controller.
- Password protection must be activated as needed.
- The country's local safety requirements must be met.
- Immediately after completing work, all safety and security equipment must be reinstalled and rendered functional.
- Non-compliance with safety information can lead to the unit becoming defective, to mortal danger, and to warranty forfeit.

### 34 Wall mounting



**HAZARD!**  
The unit is not suitable for installation in areas exposed to explosion hazards.

#### 34.1 Selecting the installation location

- Level, flat surface.
- The free space surrounding the unit must be large enough for trouble-free operation and maintenance. Covers must remain removable. Be sure that the electrodes are freely accessible in order to guarantee trouble-free handling.
- The control unit's casing opens to the left.
- The control unit's display should be approximately at eye level.
- At least 20 cm of clearance is needed underneath the unit for installing hoses.
- No parts sensitive to moisture underneath the unit
- A damp room DC SCHUKO socket no more than 1.5 m away.
- All hoses and cables must be installed free from kinks and abrasion.
- No hose line should be longer than 5 m.

## 35 Electrical connection

- Hoses must not be run directly over pipes or systems that transmit heat.
- Direct sunlight, thermal radiation, frost, and moisture must be avoided.
- Ensure sufficient ventilation.
- No current-carrying lines, relays, electric motors, etc. in the near vicinity.
- The installation location should be as close to measuring water extraction and return as possible.

### 34.2 Installation

- The base plate can be used as a drill template by holding it on the intended location and marking the drill holes on the wall.
- After the base plate is safely anchored to the wall, including mounted controller, and measuring sensory, the covers can be inserted into the tongue and groove connection supplied.

## 35 Electrical connection

PoolManager® is designed and built according to the applicable guidelines. Prior to leaving the factory, it was carefully inspected and departed from the factory in a state free of technical issues.

Hazard-free operation is only possible when all information included in this manual is observed.

The supply current for the unit must not exceed 240 V / 50 Hz. The permissible operating temperature is 0 to 50 °C, permissible air humidity is 0-90 %.

As is standard with all electrical connections, be sure that all plug connections are secured against water.

### 35.1 Measurement grounding

There must be a grounding (protective earth connection) for both measuring water extraction and return. The ground connections have to be connected with a safe ground in order to facilitate the conduction of potential in pool water.



#### IMPORTANT NOTICE

The ground **MUST** be installed. Ensure that this ground functions without issues. Please always make sure that there is no residual current to the swimming pool's water. In cases of doubt, we recommend having measurement taken professionally.

### 35.2 Blocking via the circulation pump

PoolManager® is equipped with a double pump lock, which offers the highest level of security. That is why it has 2 separate power connections, with one power connection directly to the controller and the other connection supplying the dosing pump.

On the one hand, the flow switch in the measuring cell ensures that the dosing pump is only turned on when there is sufficient water flowing through the measuring cell.

On the other hand, the dosing pumps are supplied via a separate power supply input. That power input absolutely must be connected such that the dosing pumps are only supplied with power when the circulation pump is running.

This guarantees that the dosing pump only runs when the pool water is running through the circulation system.

## 36 Installation into the circulation system

Depending on the maintenance method chosen, install PoolManager® on the circulation system as follows.

### 36.1 PoolManager® Chlorine installation diagram

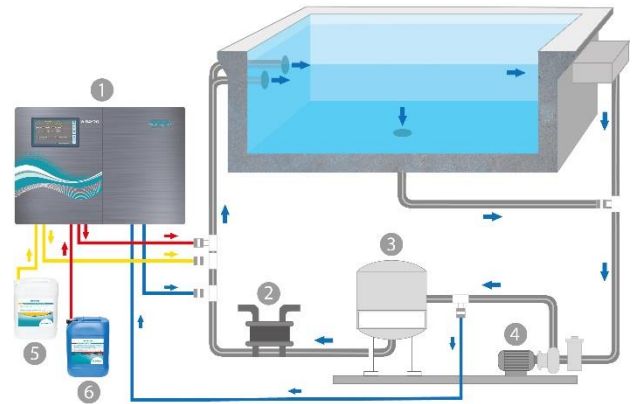

1. PoolManager® Chlorine
2. Heat exchanger/Heating
3. Sand filter
4. Circulation pump
5. pH-Minus / pH-Plus
6. Sodium hypochlorite

### 36.2 PoolManager® Oxygen installation diagram

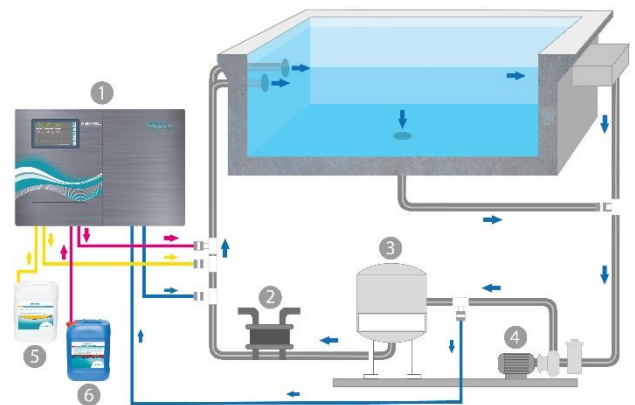

1. PoolManager® Oxygen
2. Heat exchanger/Heating
3. Sand filter
4. Circulation pump
5. pH-Minus / pH-Plus
6. Bayrosoft® Light



### 36.3 PoolManager® Bromine installation diagram

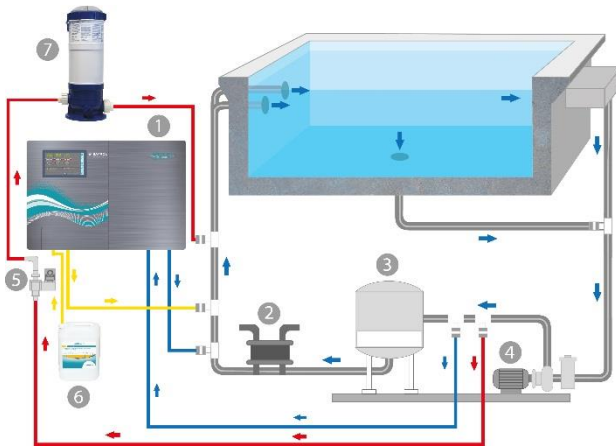

1. PoolManager® Bromine
2. Heat exchanger/Heating
3. Sand filter
4. Circulation pump
5. Magnet valve
6. pH-Minus / pH-Plus
7. Brominator

### 36.4 PoolManager® PRO installation diagram

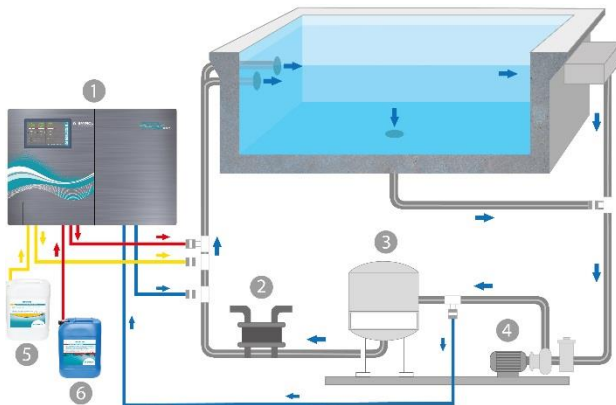

1. PoolManager® PRO
2. Heat exchanger/Heating
3. Sand filter
4. Circulation pump
5. pH-Minus / pH-Plus
6. Sodium hypochlorite

### 36.5 PoolManager® installation



#### IMPORTANT NOTICE

Ensure that connections are sealed tightly for all hose and assembly connections.  
No liability for any leakage!

#### 36.5.1 Connection with the circulation system

- Install the tapping saddles for measuring water extraction and return and injection valves as shown in the diagrams.
- Use the Teflon tape provided to install measuring water extraction and return, as well as injection valves.



#### PoolManager® Bromine only

- Install the tapping saddles for water extraction and return for the Brominator according to the diagram
- Connect the Brominator with the solenoid valve and circulation system as shown in the diagram.
- Connect the measuring water extraction with PoolManager® pre-filter using a piece of measuring water hose that is sufficiently long.
- Connect the measuring cell's outlet with measuring water return using a piece of measuring water hose that is sufficiently long. Measuring water can also be fed back to the surge water container, if present.
- Connect the pressure line (hose) provided for pH with the pressure side (right connection) of the right hose pump. Connect the other end with the injector on the circulation line.



#### PoolManager® Chlorine and Oxygen only

- Connect the pressure line provided for sodium hypochlorite or Bayrosoft® Light with the pressure side (right connection) of the hose pump for disinfection. Connect the other end with the injector on the circulation line.
- Connect the suction lance's hose for pH with the suction side (left connection) of the dosing pump for pH.
- Plug the suction lance's plug into the respective socket on the unit (see imprint on the unit).



#### PoolManager® Chlorine and Oxygen only

- Connect the suction lance's hose for sodium hypochlorite or Bayrosoft® Light with the suction side (left connection) of the dosing pump for disinfection.
- Plug the suction lance's plug into the respective socket on the unit (see imprint on the unit).
- Open the package with the liquid water maintenance products and insert the suction lances vertically down to the floor.



#### IMPORTANT NOTICE

Place the packaging for liquid water maintenance products (pH-/pH+, sodium hypochlorite, Bayrosoft® Light) into appropriate containers.

36.5.2 Measurement system

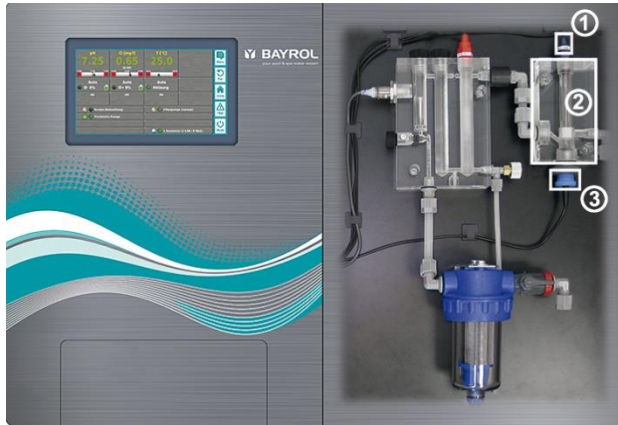

36.5.2.1 Chlorine measurement cell (PoolManager PRO only)

The content of chlorine in the swimming pool water is measured by a potentiostatic chlorine cell (2). This is a 3-electrode system using a standard redox electrode (1) (includes 2 electrodes) and a gold electrode (3) as the third electrode.

The gold plate in the chlorine cell must be covered with blue glass pearls for continuous cleaning.



Make sure that gold electrode covered with the correct amount of blue glass pearls (1 layer of pearls covering the electrode).

36.5.2.2 Measuring water adjustment

Use the black adjustment screw to the left of the measuring cell only for making fine adjustments to flow rate. Larger changes can be made using the tap on the measuring water extraction.



PoolManager® Chlorine, Bromine, and Oxygen only

Configure water flow through the cell such that there is ca. 1-2 mm of clearance between the float and the top edge of the proximity switch.



PoolManager® PRO only

Configure water flow through the measuring cell such that the cleaning balls sufficiently and evenly rotate on the gold plate. Avoid too much flow, which can be recognised when the cleaning balls jump.

Bubble formation in the measuring cell:

Should you find bubbles are forming in the measuring cell, then inspect the measuring water circuit for leakage.

If the measuring water circuit is sealed tightly yet there are still bubbles forming, then please open up the black adjustment screw on the left side of the measuring cell further and restrict measuring water using the tap on the measuring water extraction. Small adjustments are made using the black adjustment screw.

37 Maintenance



IMPORTANT NOTICE

Use only replacement parts and sensors from the manufacturer. Otherwise, the warranty will be forfeited.



IMPORTANT NOTICE

Electrodes are wear and tear parts and therefore not included in the warranty.

Some PoolManager® parts are subject to abrasion due to chemical and mechanical strain. Therefore, regular control is necessary for safe, long-term operation. Regular precautionary maintenance of the system protects against unplanned operating interruptions.

37.1 Monthly maintenance

- Visual inspection of all dosage lines and hoses
- Check filter screen, clean as needed
- Check the water values with a digital water tester (e.g., "Electronic Pooltester"), readjust the values and calibrate the electrodes if necessary

37.2 Quarterly maintenance

- Visual inspection of all dosage lines and hoses
- Check screen, clean as needed
- Check the water values with a digital water tester (e.g., "Electronic Pooltester"), readjust the values and calibrate the electrodes if necessary
- Calibration of pH and redox electrodes using the buffer solutions provided
- Calibration of chlorine electrodes (PoolManager® PRO only)
- Maintenance of injection points

37.3 Annual maintenance

- Visual inspection of all dosage lines and hoses
- Check screen, clean as needed
- Check the water values with a digital water tester (e.g., "Electronic Pooltester"), readjust the values and calibrate the electrodes if necessary
- Replace pH and redox electrodes and calibrate using fresh buffer solutions
- Replace the chlorine measuring cell's glass electrode and calibrate the chlorine measurement cell (PoolManager® PRO only)
- Maintenance of injection points
- Replace the hoses on the dosing pumps



PoolManager® PRO only

The lifespan of the gold electrodes in the chlorine measuring cell is approx. 5 years. Depending on the degree of utilisation, it may be necessary to replace a gold electrode earlier.



NOTE

Do not use buffer solutions that are more than 12 months old.



NOTE

The lifespan on glass electrodes depends on the operating conditions and the water's properties. It is

normally approx. 12 months; storage time is applied at 50 %.



**NOTE**  
Maintenance frequency is only partially dependent upon utilisation intensity. Chemical strain, for example, on plastic parts begins immediately upon first contact with the medium and is not dependent upon the type of utilisation.

### 37.4 Cleaning

Clean the unit's surface as needed using a towel that is soft and free of fuzz. Only use a small amount of water, if necessary.



**IMPORTANT NOTICE**  
Do not use aggressive cleaning products.

### 37.5 Dosing pump hose replacement



**NOTE**  
Never grease hoses!



**NOTE**  
Only original replacement pump hoses may be used!



**NOTE**  
Hose of pump are wear and tear parts and therefore not included in the warranty.



**HAZARD!**  
**Hazard due to chemicals**  
Corrosive product residue may come out of the pump hose when pulled off.

**Potential consequence: Grave health hazard (chemical burns) and material damage**

- Always be sure to empty pump hoses and feed lines first.
- When necessary, use protective eye wear and gloves and protect the surrounding area from escaping product residue using a towel.



**HAZARD!**  
**Hazard due to rotating parts**  
The dosing pump's rotor may start immediately.  
**Potential consequence: Crushing of fingers!**  
Ensure that the dosing pump remains separated from the operating voltage (unplug) when replacing a hose!

The dosing pump's hose is replaced without removing the rotor.

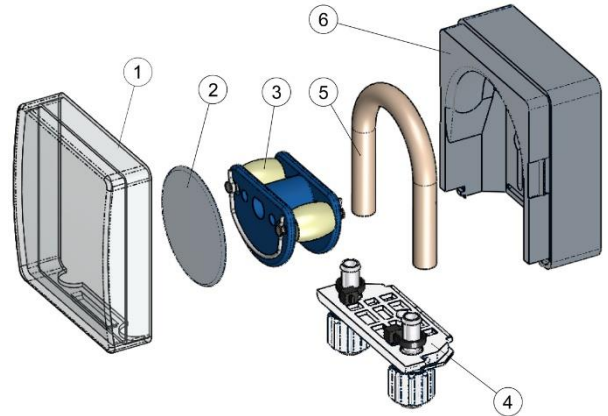

- Remove the empty suction and pressure hoses from the hose fastener. To do so, loosen the white clamp screws.
- Remove transparent cover 1 from the pump.
- Remove transparent cover 2 from the rotor.
- Turn rotor 3 such that the flat side faces left and is vertical.
- Pull hose fastener 4 from its bracket and lift on the left side.
- Turn rotor 3 clockwise and remove the cable while lifting on it until it is completely free.
- To install, perform in the opposite order.

Either the hose can be replaced alone, or the hose and hose fastener can be replaced jointly.

It is recommended to replace hose and hose fastener jointly.

Art. no.	Designation	Application
127313	Replacement hose set 1.5 l/h (hose with hose fastener)	Chlorine and pH for pool sizes up to ca. 100 m <sup>3</sup>
127356	Replacement hose set 3.0 l/h (hose with hose fastener)	Chlorine and pH for pool sizes of approx. 100 m <sup>3</sup> to ca. 200 m <sup>3</sup> and for dosing Bayrosoft® Light.
127303	Pump hose 1.5 l/h (hose without hose fastener)	Chlorine and pH for pool sizes up to ca. 100 m <sup>3</sup>
127353	Pump hose 3,0 l/h (hose without hose fastener)	Chlorine and pH for pool sizes of approx. 100 m <sup>3</sup> to ca. 200 m <sup>3</sup> and for dosing Bayrosoft® Light.



**NOTE**  
If only the hose is being replaced, then the following absolutely must be observed during installation

- The hose sits securely in the grommets.
- Under no circumstances may the hose be twisted when installed.
- Ensure the hose clip sits securely.

### 38 Winter breaks

No special measures are necessary for short breaks in usage (e.g. several days).

For longer operational breaks of multiple weeks, such as the winter months, the following work must be performed:

- Remove suction lances from the canisters and rinse them with water.
- Close packages, store them in a cool and dry location protected from UV radiation.
- Rinse hose pumps with water. To do so, run the pumps in manual mode.
- Remove the unit from the power supply.
- Remove the dosing hoses from the pumps.
- Turn off measuring water supply.
- Empty the measuring water circuit and hose pumps completely.
- Remove glass electrodes (pH and Rx electrode) from the measuring chamber and seal screw apertures.
- Store electrodes in the original containers with the solution contained (KCl).
- Store electrodes in a location from frost.

After winter has passed, follow the instructions for first start-up to render the system operational again.

In doing so, be sure to inspect all components for their capacity to function.

All dismantled parts (electrodes, dosage hoses) must be remounted at their intended locations.

Check the settings in PoolManager®. In doing so, follow the procedure for first start-up and calibrate the electrodes as described.

### 39 Decommissioning

If disposing of the device after its service life, be sure to rinse it thoroughly and drain all water. This device has been manufactured in compliance with the ROHS directive and the German laws on electronic equipment disposal. Do not dispose of this equipment along with regular waste.

Deliver the device to a suitable collection point. Refer to the rules and laws of your area.

### 40 Commissioning

PoolManager® has a menu for the first start-up. This menu covers all parameters relevant to successful installation.

This menu for first start-up can be called up at any time as follows:



Service functions → Commissioning step by step

The following steps are executed:

Action	Entry
<b>Step 1: Menu language</b>	
Configuration of menu language	
<b>Step 2: Set default values</b>	
Here, the desired default set can be selected and activated.	Here, select the default set that best fits. In cases of doubt, please check all default values for their validity for the respective installation. For safety reasons, activation of the defaults has to be confirmed at this point.
<b>Step 3: System parameters</b>	
Configuration of pool and system parameters	Pool volume of the connected swimming pool. Hose configuration of the pump hoses used. This display is used to check the settings made at the factory according to device configuration.
<b>Variation A: PoolManager® Oxygen:</b>	
<b>Step 4: Calibration</b>	
Calibration (comparison) of measured pH value	1-point calibration pH. Please proceed as described in the section <i>Calibration pH</i> .
<b>Step 5: Control parameters pH</b>	
Configuration of the most important parameters for pH control	When refilling the pool, it may be sensible to expand the top and bottom pH value alarms and to adjust the p-range, as the pH value can fluctuate somewhat during the starting phase. <b>CAUTION:</b> If the parameters are changed, make absolutely sure that the values are set back as soon as the pool water has stabilised. You can also use the configuration assistant.
<b>Step 6: Manual dos. O2 (Bayrosoft® Light)</b>	
Start manual dosing	The dosing volume (for 1.5 l Bayrosoft® Light /10 m³ water volume) is calculated upon entering the pool volume and can be started here. In order to increase the dosage volume for the first dosage, thereby increasing the certainty of disinfection, it's also possible to select 2x or 3x the dosage volume.
<b>Step 7: Dosage parameters O2</b>	
Configuration of the most important parameters for automatic Bayrosoft® Light dosing.	Dosage volume is calculated by entering the pool volume and is displayed here to check (1.5 l Bayrosoft® Light /10 m³ water volume). It can be changed manually. Select the dosage day such that it is directly before the largest water usage expected (e.g., high amount of swimming). Temperature compensation ensures that more Bayrosoft® Light is dosed for higher water temperatures (higher product consumption). It should be set at least to normal.



Variation B: PoolManager® Chlorine/Bromine	
<b>Step 4: Calibration</b>	
Calibration (comparison) of measured value for pH and redox	1-point calibration pH. Please proceed as described in the section <i>Calibration pH</i> . 1-point calibration mV (optional). Please proceed as described in the section <i>Calibration redox (mV)</i> .
<b>Step 5: Control parameters pH</b>	
Configuration of the most important parameters for pH control	When refilling the pool, it may be sensible to expand the top and bottom pH value alarms and to adjust the p-range, as the pH value can fluctuate somewhat during the starting phase. <b>CAUTION:</b> If the parameters are changed, make absolutely sure that the values are set back as soon as the pool water has stabilised. You can also use the configuration assistant.
<b>Step 6: pH Value configuration</b>	
Possibility for automatically / manually setting the pH value in the pool water	Display shows the configured pH setpoint and the current pH value in the pool water. <b>NOTE</b> The pool water's pH value first has to be set to pH 7.2 in order to facilitate configuration of the redox value without issue. Set pH operation mode to auto if PoolManager® should make the configuration fully automated. This process will take some time, depending on pool size and water quality. Set operating mode to manual if you would like to configure the pH value via manual addition of pH-elevator and -reducer.
<b>Step 7: Manual dosing mV (Cl / Br)</b>	
Configure the desired chlorine or bromine level and calculate the associated redox (mV) value	The matching setpoint will depend on the pool. It has to be calculated for the water in the respective pool. Proceed as follows: Set the pH value to pH 7.2 (see previous step) Set the desired chlorine level in the pool via manual dosing (or via manual addition of chlorine) The volume of sodium hypochlorite dosed is determined by PoolManager® via the pool volume entered. This volume can be overwritten manually. Check the desired chlorine level via manual measurement (DPD). The redox value in [mV], which PoolManager® shows for the desired chlorine volume, is also the value that has to be entered as the setpoint in the next step.
<b>Step 8: Control parameters redox (mV)</b>	
Configuration of the most important parameters for redox control	Set the mV value as the setpoint you read in the previous step for the desired chlorine level. Adjust the bottom and top alarm accordingly. Check the proportional range. You can also use the configuration assistant.

In the individual menu pages, it is possible to scroll forward and backward at any time.

For further information, please refer to the corresponding chapters in this user's manual or to the help function on the device.

## 41 Dosing pumps

### 41.1 Peristaltic pumps

The standard PoolManager® dosing pumps are so-called peristaltic pumps (hose pumps). Rollers on the rotor continuously squeeze the dosage hose, thereby providing for the dosing of maintenance products.

The pump's dosage hose is replaceable. The pump's dosing output can be adjusted via various hose diameters.

The following table shows the standard dosing outputs on PoolManager® dosing pumps.

Function	Standard dosing hos (dosing output)
pH (pH-Minus / pH-Plus)	1.5 l/h
Cl (Sodium hypochlorite)	1.5 l/h
O2 (Bayrosoft® Light)	3 l/h

The pumps used are run with a 230 V~ power supply. PoolManager® control system periodically turns the dosing pumps on and off within a fixed dosage cycle (typically 60s) in order to realise the dosing output calculated. A higher dosing output will lead to longer turn-on times.

#### 41.1.1 Electrical connection



**Required user qualification:**  
**ELECTRICAL SPECIALIST**

The electrical connection for eco mode may only be performed by an ELECTRICAL SPECIALIST as defined in the chapter *User qualification*.

The following figure shows the internal wiring of the three dosing outputs for disinfection, pH-, and pH+. All connections shown are run internally as conductor paths.

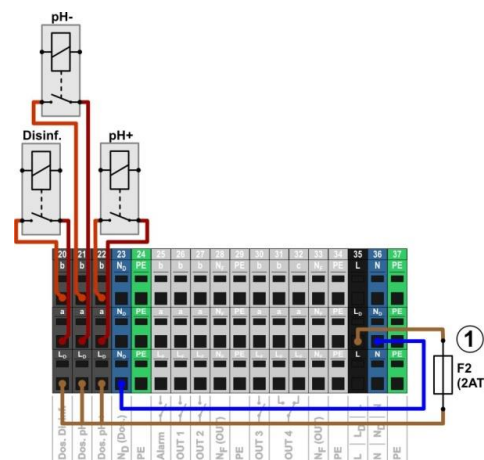

1 Fuse 2 AT for the 230 V~ Phase L<sub>D</sub> for supplying dosing outlets

The following terminal blocks are allocated to the dosing outputs:

Dosing output	Terminal block	Function
Disinfection	20	On / off switch
pH- (pH-Minus)	27	On / off switch
pH+ (pH-Plus)	22	On / off switch

Each terminal block is set up as follows:

Terminal	Function
b	Working contact
a	Centre contact
L <sub>D</sub>	Supply phase 230 VAC for dosing outputs. Can be bridged to the centre contact if needed in order to control 230 VAC devices.

The following figure schematically shows the connection of a standard dosing pump for 230 V~. The pump is connected to the disinfection dosing output. For pH- and pH+, connection is correspondingly on terminal blocks [21] and [22], respectively.

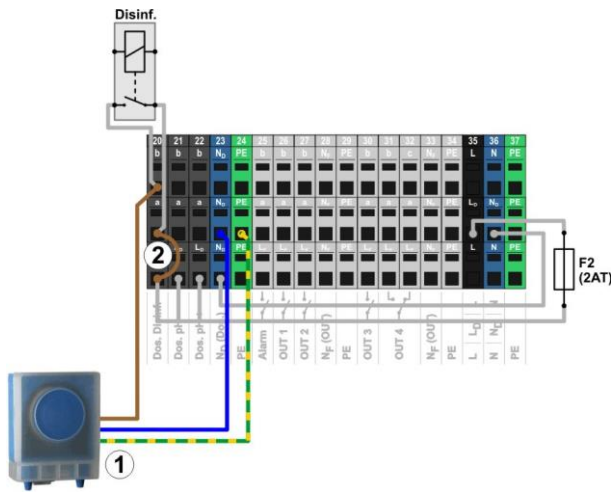

- 1 Standard dosing pump 230 V~ (peristaltic pump)
- 2 Wire bridge in the terminal box from phase L<sub>D</sub> to centre relay contact a



**INFO**

**Connection of neutral conductor N and PE**

A dosing pump's neutral conductor N and protective earth PE can be connected to the N<sub>D</sub> and PE terminal blocks as shown in the figure.

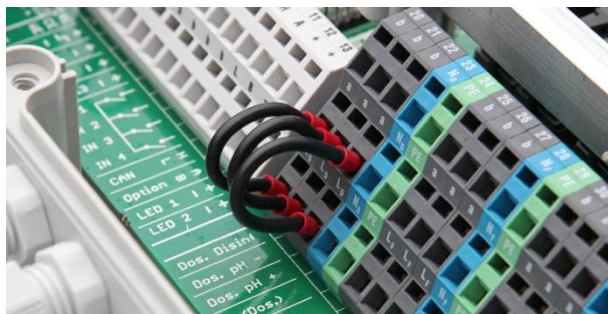

Wire bridges in the terminal box from phase L<sub>D</sub> to the dosage outputs' centre relay contact a

**41.1.2 Configuration**

You'll find all relevant settings in the menu



Service Functions → Configuration dosing pumps

Menu Configuration dosing pumps	
Pump type pH / mV (Cl) / O2	For peristaltic pumps, select <i>Standard</i> .
Pump config. pH / mV (Cl) / O2	Select the hose used [l/h] or select the setting <i>manual</i> if none of the hose configurations matches.
For Pump config. only = <i>manual</i>	
Pump capacity pH / mV (Cl) / O2	Enter the correct capacity for the corresponding dosing pump in [l/h].



**IMPORTANT NOTICE!**

**Incorrect configuration of the pump capacity**

If a pump's dosing output is not configured correctly, then the following problems will arise:

- The calculation for duration of manual dosing is not correct.
- The configuration assistant for configuring control parameters calculates erroneous settings.
- The O2 (Bayrosoft® Light) dosing amounts are not correct (overdosage or underdosage!)

**41.2 Membrane dosing pumps**

It's possible to use membrane dosing pumps (magnet dosing pumps), especially for higher dosing outputs in large pools. PoolManager® also supports this pump type via special triggering with dosage pulses.

A membrane dosing pump generally has its own power connection and is permanently connected to the power grid. When the pump is set to *external* operating mode, individual pump strokes can be triggered via an external potential free contact. Depending on the pump type and the settings, a certain amount of liquid is dosed on the pump.

PoolManager® supports the triggering of individual pump strokes. A maximum of 240 dosage pulses per minute can be emitted. This operating mode can be activated and configured in PoolManager® menu (*Service functions* → *Configuration of dosing pumps*).

**41.2.1 Suitable membrane dosing pumps**

In principle, all pump types are suitable that allow triggering of individual pump strokes via a potential free contact in *External* operating mode. PoolManager® can trigger a maximum of 240 strokes/min. The switch duration of one dosing pulse is fixed to 125 ms.

For many pump types, the manufacturer offers a special trigger cable for external triggering, which can be used for connection to PoolManager®.

### 41.2.2 Electrical connection



**Requisite user qualification:**  
**ELECTRICAL SPECIALIST**

The electrical connection for eco mode may only be performed by an ELECTRICAL SPECIALIST as defined in the chapter *User qualification*.



**HAZARD!**

**Destruction of control input via 230 V~**

The pump may be destroyed if the control input of a membrane dosing pump is accidentally placed under 230 V~.

**Potential consequence: Destruction of membrane dosing pump**

- Be absolutely sure to connect the dosing output as a potential free switch.
- If necessary, remove the wiring bridge between the terminals L<sub>F</sub> and a of the dosing output being used.



**Hazard!**

**Jammed relays from switching the power supply on membrane dosing pumps**

Do not use the controller to power the membrane pumps on and off using the 240 V output. Membrane dosing pumps at times draw extremely high starting currents, which can lead to jammed contacts on the dosing relays and therefore lead to overdosing.

**Potential consequence: Death or the gravest degree of injury, heavy material damage.**

- Always trigger membrane dosing pumps potential free via their control input.

The following figure schematically shows the connection of a membrane dosing pump to a PoolManager® dosing output. The pump is connected to the disinfection dosage output. For pH- and pH+, connection is on terminal blocks [21] and [22], respectively.

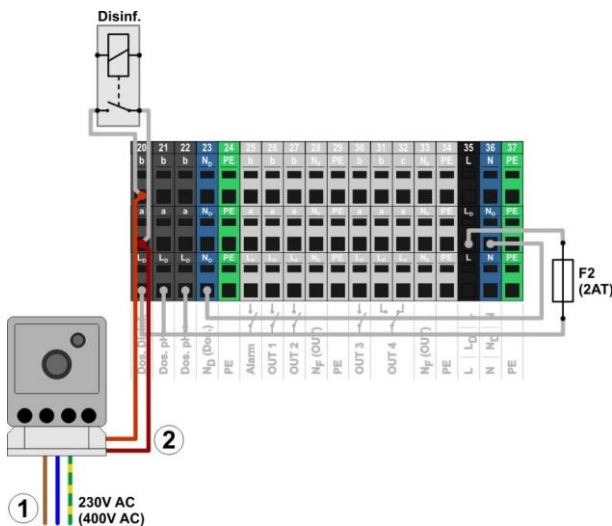

- 1 Membrane dosing pump's 230 V~ external power supply
- 2 Membrane dosing pump's control input connected with the dosing output (potential free switch contact)

### 41.2.3 Configuration

After connecting one or multiple membrane dosing pumps, correct triggering has to be activated and configured in PoolManager® menu. You'll find all relevant setting in the menu



Service Functions → Configuration dosing pumps

Selecting the pump type *Membrane pump* will activate the triggering of individual dosing strokes via PoolManager®.

The default setting for pump type is *Standard*. This operating mode is intended for conventional peristaltic pumps.

Menu Configuration dosing pumps	
Pump type pH / mV (Cl) / Cl	For membrane pumps, select <i>Membrane pump</i> .
Max. no. of strokes pH / mV (Cl) / Cl	Enter the desired maximum number of strokes [strokes/min] at a dosing output of 100%. For more information, also review the section <i>Determining output</i>
Pump capacity pH / mV (Cl) / Cl	Enter the correct maximum pump capacity for the corresponding dosing pump in [l/h] (for the maximum number of strokes entered)



**IMPORTANT NOTICE!**

**Incorrect configuration of the pump capacity**

If a pump's dosing output is not configured correctly, then the following problems will arise:

- The calculation for duration of manual dosing is not correct.
- The configuration assistant for configuring control parameters calculates erroneous settings.



**INFO**

**Membrane dosing pump for O<sub>2</sub> (Bayrosoft® Light)**

For O<sub>2</sub> dosing (Bayrosoft® Light), the pump type *Membrane pump* cannot be selected. For Bayrosoft® Light dosing, however, a membrane pump can be triggered with simple turning on and off, like a peristaltic pump. The output desired can be configured directly on the pump.

This variation is sufficient, as PoolManager® always doses either 100 % or not at all. Therefore, variable triggering of individual pump strokes is not necessary.

#### 41.2.3.1 Determining the pump capacity

The maximum number of strokes per minutes must be configured such that the desired maximum output in l/h is yielded at 100 % dosing output.

Output can be determined for certain stroke rates with the data sheet for the pump being used, such as for 60 strokes/min, 120 strokes/min, or 180 strokes/min.

For many pumps, stroke length can also be configured at the pump. This also makes it possible to adjust the pump capacity to match needs.

**Example:**

A maximum pump output of 2.0 l/h is planned for a system. The maximum stroke frequency on the pump is 180 strokes/min.

Using the pump's data sheet, the desired output of 2.0 l/h is yielded with maximum stroke length (100 %) and a stroke frequency of 40 %, i.e., 72 strokes/min.

Therefore, the maximum number of strokes must be set to 72/min in PoolManager® in this case. Then PoolManager® will generate 72 dosing pulses per minute at maximum dosing output (100 %). This will lead to the desired maximum dosing output of 2.0 l/h.

## 42 Changing the care method

The maintenance program (oxygen (O2 / Bayrosoft® Light) / Chlorine (Cl) / Bromine (Br)) is changed in the menu



Menu hotkey



Service Functions

- Device Type and Care Method
- Select care method (Cl / Br / O2)

The new program that is desired and a matching code number has to be entered. The code number depends on the current care method **and** on the new care method selected:

Current program	New program	Code number
PoolManager® O2	PoolManager® Cl	122
PoolManager® O2	PoolManager® Br	123
PoolManager® Cl	PoolManager® O2	221
PoolManager® Cl	PoolManager® Br	223
PoolManager® Br	PoolManager® O2	321
PoolManager® Br	PoolManager® Cl	322

## 43 Software update

PoolManager's® internal software (firmware) can be updated at any time using a standard USB memory stick.

The most current software version will be available for download in the retailer section on the BAYROL website.

All software is packed into one file (file size ca. 25 MB). The file name changes with each version and has the following format, for example: firmware\_PM5-2.2.3-4882.bin. In this example, 2.2.3 indicates the software's version number.

### 43.1 Step by step



#### IMPORTANT NOTICE!

##### Loss of power during software update

Ensure that PoolManager® is continuously supplied with power throughout the entire software update. If there is a power outage during the updating process, then the update will fail and will definitely have to be repeated.



#### IMPORTANT NOTICE!

##### Plugging in the USB memory stick

PoolManager's® USB interface supports hot plug & play, i.e., the memory stick can be plugged in during ongoing operation.

However, it is expressly recommended to turn off PoolManager® power supply for plugging in the USB. When plugging in during ongoing operation, it's possible for PoolManager® sensitive electronics to be damaged due to electrostatic charges upon coming into contact.

1. Copy the file with the current software into the main directory (root directly) on your USB memory stick (e.g., M:). Do not, under any circumstances, copy the file to a sub-directory, for PoolManager® only searches for potential software updates in the root directory.
2. Turn off PoolManager® power supply.
3. Open the front of PoolManager® casing as shown in the following figures.



4. Put the USB memory stick with the software update into PoolManager® internal USB slot.



5. Close the front of the casing and turn the power supply back on.
6. Wait until the boot procedure is complete. This takes approx. 1 - 2 minutes.
7. Select the software update function in the menu as follows:



Service functions

- Software update (from USB stick)

8. Press the button *Start software update*
9. PoolManager® automatically performs a restart in order to launch the software update
10. The screen background is black throughout the update. There are various icons and text messages to inform you about the software update's progress.





11. The updating process takes about 5 minutes. Once completed, PoolManager® will perform an automatic restart and will boot with the updated software.
12. You can then remove the USB stick. To do so, turn off PoolManager® voltage supply.

## 44 Network connection



**Required user qualification:**

### IT SPECIALIST

The network connection may only be performed by an IT SPECIALIST as defined in the chapter *User qualification*.

PoolManager® offers comprehensive and very easy opportunities for remote access from a local network or from the Internet.

In order to use these opportunities, PoolManager® has to be connected to a TCP/IP network (TCP/IP is the transmission protocol used on networks and the Internet).

In the PoolManager® terminal box, there is a standard Ethernet slot (RJ45). A standard network cable (Cat5 or Cat6) can be plugged into that slot.

The network cable is fed through a special large cable fitting into the terminal box in order to maintain IP65 rating.

### 44.1 Step by step

1. Turn off PoolManager® power supply.
2. Loosen the four screws on the terminal box cover and remove it.



3. Loosen the large cable fitting on the far left.
4. Feed a standard network cable with an RJ45 plug into the terminal box as shown in the following figures.

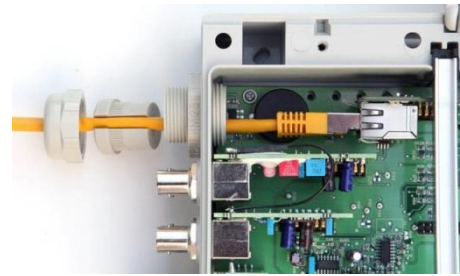

5. Next, run the cable through the cable fitting's cover and through the fitting

itself.

6. Plug the cable into the RJ45 slot. Be sure the plug connection locks securely
7. Pull the slotted rubber seal over the cable as shown in the figure.

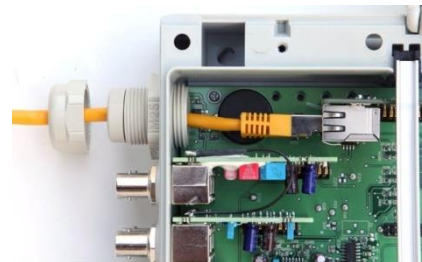

8. Press the rubber seal into the cable fitting.

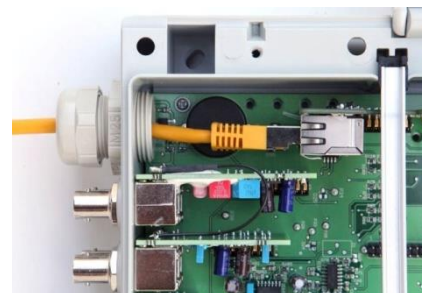

9. Screw the cable fitting tight again in order to obtain a reliable seal.
10. Close the casing again. Tighten the screws on the terminal box cover by hand in order to obtain a reliable seal.
11. Turn PoolManager® voltage supply on again.

### 44.2 Options

#### 44.2.1 Wireless network (WLAN / WiFi)

##### 44.2.1.1 PoolManager® wireless connection

It is easy to integrate PoolManager® into an existing wireless network. To do so, you'll need a wireless network adapter (also known as WLAN adapter or WiFi adapter). These kinds of adapters can be found for reasonable prices at specialised shops. One example of a current model would be the *Wireless Internet Adapter (WNCE2011)* from the manufacturer Netgear.

The adapter is connected with PoolManager® using a standard network cable and establishes a transparent data connection from PoolManager® to the existing wireless network.

The wireless adapter has to be configured in advance just one time so that it can establish the connection to the desired wireless network automatically. That basic configuration is usually done with the help of a PC. Please refer to the documentation of the wireless adapter being used for more details.

The following figure schematically shows a connection between PoolManager® and a wireless network.



- 1 Standard network cable (Ethernet)
- 2 Wireless network adapter (WLAN / WiFi adapter)
- 3 Wireless network



**TIP**  
**Poor reception conditions**

If there are poor reception conditions at the site where PoolManager® is installed, then you can use a (long) standard network cable between PoolManager® and the wireless adapter to install the wireless adapter at a location with good reception conditions.

**44.2.1.2 Access via a wireless network**

If there is no wireless network present into which PoolManager® can be integrated, then it is easy for you to set up a network in order to, for example, access PoolManager® wirelessly using your mobile devices.

To do so, you need a standard network router with an integrated wireless network (WLAN / WiFi). PoolManager® connects to the network router via network cable, wireless adapter, or PowerLAN. PCs and mobile devices can also connect with the network router via network cable or wireless network, thereby acquiring remote access to PoolManager®.

The network router has to be configured by an expert once upon being used for the first time. Please refer to the documentation of the network router being used for more details.

The following figure schematically shows the set-up for this kind of network.



- 1 Standard network cable (Ethernet)
- 2 Network router with wireless network (WLAN)
- 3 Local network (wireless and / or Ethernet)
- 4 PCs and mobile devices on the local network have remote access to PoolManager

**44.2.2 PowerLAN (dLAN)**

PowerLAN technology (also called dLAN (direct LAN) or Powerline Communication (PLC)) uses the building's 230V~ system for setting up network connections. Data are transmitted using the existing power lines.

With the corresponding PowerLAN adapters, which are available from specialist shops, a network connection can be set up between two normal wall plugs.

In many cases, PowerLAN technology represents an interesting option for integrating PoolManager® into an existing network.

The following figure schematically shows an example of this kind of system:

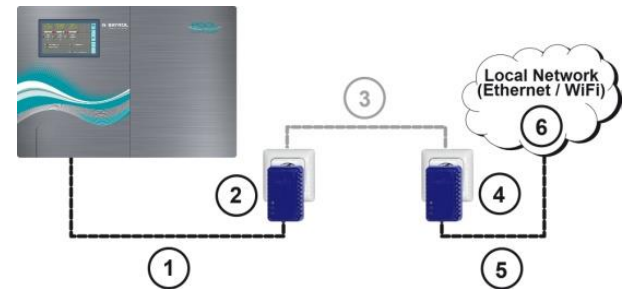

- 1 Standard network cable (Ethernet)
- 2 Plug with PowerLAN adapter
- 3 The building's existing 230V~ power network
- 4 Plug with PowerLAN adapter
- 5 Standard network cable (Ethernet) as a connection to the local network (e.g., to the network router).
- 6 Local network (wireless and / or Ethernet)

**45 Remote access to the PoolManager®**

**45.1 Remote Access via BAYROL Web Portal**

For easy and convenient remote access BAYROL Technik provides a Web-Portal free of charge for the user. For connection instructions please refer to the manual which can be downloaded from the website <https://www.bayrol-poolaccess.de> in the Download-Center (<http://www.pm5-update.net>). For remote access without using the web portal please follow the instructions in the following chapters.

**45.2 Direct Access from the Internet without BAYROL Web Portal**

This section describes the necessary configuration steps to enable remote access to the PoolManager® from a local (TCP/IP) network.



**Required user qualification:**

**IT SPECIALIST**

Configuration of remote access from the local network must be performed by an IT SPECIALIST as defined in the chapter *User qualification*.

**45.3 Local network (IP) address**

In a TCP/IP network (Ethernet and/or wireless network), each device has to receive a unique IP address with which it can be accessed. TCP/IP is the designation of the standardised transmission protocol on the Internet and on local networks (TCP = Transmission Control Protocol, IP = Internet Protocol).

An IP address consists of two sections:

1. The first section is the network ID, which is identical for all devices within the same network.
2. The second section is the host ID, which is issued only one time within a network and accesses a specific device.

An IP address always consists of a series of four numbers separated by a dot. Each number can have a value between 0 and 255 (e.g., 192.168.1.100).



**INFO**

**Network ID and host ID for IP addresses**

In most networks, the IP address is broken down as follows:

- The first three numbers are the network ID
- The fourth number is the host ID

There are exceptional cases with different breakdowns, e.g., two numbers for the network ID and two for the host ID.

The corresponding breakdown is determined by the network's subnet mask, which also consists of a series of four numbers. Each number of a subnet mask generally has the value of either 255 or 0. 255 designates the corresponding positions as part of the network ID. That is why the subnet mask has the value 255.255.255.0 on most networks.

**Example:**

Subnet mask	255.255.255.0
IP address	192.168.1.100
Network ID	192.168.1
Host ID	100

The most common network IDs for home networks are 192.168.x (x = 0, 1, 2, ...). The host ID can be in the range of 1...254. The host IDs 0 and 255 are reserved for special purposes. The host ID 1 is frequently used for the network router.

**Example:**

In a network with the network ID 192.168.0, the IP-address range available is

- 192.168.0.1...192.168.1.254

In order to integrate PoolManager® into a local network, its IP-address has to be properly configured for the network.

- PoolManager® IP address has to be within the permissible range for the respective network. PoolManager® has to use the network-ID assigned by the network.
- For example, if the network router's IP address is 192.168.1.1, then PoolManager® must obtain a free network address in the range 192.168.1.2 ... 192.168.1.254.
- The IP address that PoolManager® uses must still be available on the network, i.e., it may not yet be used by another network device. A list of the IP-addresses already occupied can usually be found in router configuration (see router documentation).



**TIP**

**Determining network-ID**

You can find your network's network-ID in your network router's configuration (see router documentation).

Alternatively, you can also use a (Windows-)PC on the network to determine the network ID:

- Go to the *search* field (magnifying glass symbol) in the Windows start menu, enter *cmd*, and press *enter*
- An input window will open
- There, enter the command *ipconfig*
- Your PC's network settings are displayed:
  - IP address (or IPv4 address)
  - Subnet mask
  - Standard gateway

- You can determine the network ID using the IP address of the PC and of the subnet mask.



**TIP**

**Checking an IP address via ping**

- Go to the *search* field (magnifying glass symbol) in the Windows start menu, enter *cmd*, and press *enter*
- An input window will open
- By entering the command *ping*, you can check whether a specific IP address is already being used on the network. For example, *ping 192.168.1.88* checks whether there is a device that responds under the IP-address indicated.
- If there is no response, then the IP-address is usually still available.

**45.4 Menu Network (IP) configuration**

You can reach PoolManager® network (IP) configuration (IP = Internet Protocol) as follows:



Menu hotkey



Communication & interfaces  
→ Network (IP) configuration

The following parameters can be configured in *Network (IP) configuration*:

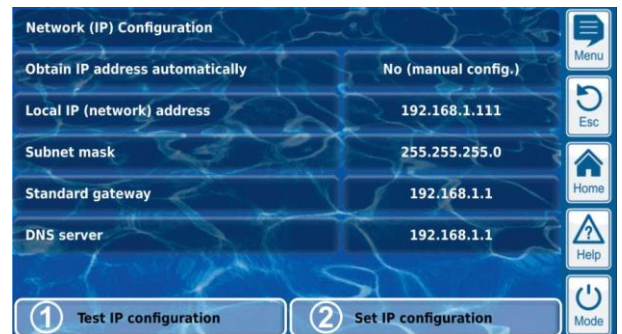

**1 Test IP configuration**

This function tests the current network configuration based on various criteria and then issues a success or error report.

**2 Activate IP configuration**

This function activates the current network settings. If the function does not trigger, then the network settings will be activated upon the next system boot.



**TIP**

**Test IP configuration**

Always run the test function prior to activating the IP configuration. This helps to recognise and remediate potential problems.



<b>Menu Network (IP) configuration</b>
<b>Assistant for automatic network (IP) configuration</b>
This assistant automatically determines a suitable network configuration, which you can then store permanently. Follow the instructions on the screen.
<b>Obtain IP address automatically</b>
Fixed to No ( <i>manual config.</i> ). For automatic IP address sourcing via DHCP protocol, the problem would be that it wouldn't be known initially and then could change again. However, the IP address has to be known for remote access to PoolManager®. Therefore, the IP address has to be entered manually and will therefore be known.
<b>Local IP (network) address</b>
Here, enter the desired IP address for your PoolManager® as described in the previous section <i>Local network (IP) address</i> .
<b>Subnet mask</b>
The subnet mask generally retains the standard value 255.255.255.0. The subnet mask only has to be adjusted if your network is using a different breakdown between network-ID and host-ID.
<b>Standard gateway</b>
In general, the IP address is entered here for the network router to which PoolManager® is connected. On many networks, the router has host-ID 1; but that does not have to be the case.
<b>DNS server</b>
The DNS server (Domain Name Server) translates URLs (e.g. www.bayrol.de) into the respective IP addresses on the Internet. In general, the network router usually assumes this task, i.e., you enter the IP address of your network router here as well.

46 Remote access from the Internet



**Required user qualification:**  
**IT SPECIALIST**

Configuration of remote access from the Internet must be performed by an IT SPECIALIST as defined in the chapter *User qualification*.



**TIP**  
**Set-up by an IT specialist**

Setting up remote access via the Internet does not represent a challenge for an IT specialist and should be taken care of quickly. However, without well-founded IT expertise, set-up can take a very long time or even be a complete failure. Additionally, security against unauthorised access can be compromised.

That is why remote access via the Internet should always be set up by an IT specialist.

To access PoolManager® from the Internet, you first have to integrate it into your local network as described in the previous chapter *Remote access from the local network*.

If the local network has a connection to the Internet, then remote access to PoolManager® from the Internet can be set up. The local network's Internet connection is generally realised via the network router, e.g., via a DSL connection to an Internet service provider.

However, in order to facilitate remote access from the Internet, there are several preparations to be made.

Initially, PoolManager® is not connected to the Internet. Rather, only the network router is. The router has its own unique IP address on the Internet. That IP address is not identical to the router's IP address on the local network. Thus, the router has two different IP address, one on the local network (such as 192.168.1.1) and one on the Internet (such as 84.59.41.24).

By contrast, PoolManager® and other devices on the local network possess only one local IP address. They do not have their own IP address on the Internet.

The following figure schematically shows a local network with an Internet connection via the router.

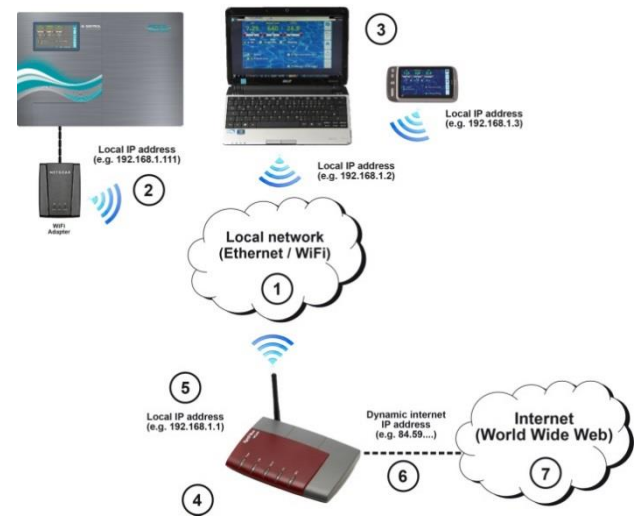

- 1 Local network (Ethernet and / or wireless network)
- 2 PoolManager® with wireless connection to the router (or, alternatively, via network cable)
- 3 Further devices on the local network (PCs and mobile devices)
- 4 Network router
- 5 Router's IP address on the local network
- 6 Router's Internet connection (with separate IP address on the Internet)
- 7 Internet (World Wide Web)

The network router receives its IP address on the Internet from the Internet service provider. In most cases, this address is dynamic, i.e., it can change at any time, such as due to a reboot of the Internet connection. This is designated a *dynamic IP address*.

Internet services providers also issue *static IP addresses*, which do remain the same. However, to do so, special service packages with static IP addresses have to be booked. Most standard DSL packages work with dynamic IP addresses.

46.1 Dynamic IP address resolution

For remote access to PoolManager® from the Internet, you'll need your router's current IP address on the Internet. If a dynamic IP address is being used, then it won't be known initially.

The DynDNS system (or DDNS (dynamic Domain Name System entry)) resolves this problem. These are services on the Internet (Web services) to which your router regularly transmits its current IP address. The DynDNS service provides you with a URL (such as <http://myPoolManager.dyn dns.org>). When you call up that URL from a browser, the DynDNS service automatically forwards the query to the current IP address of your network router. In this manner, you have access to your network router at all times, even if it is using a dynamic IP address.



## 46.2 Step by step



### INFO

#### Static IP address

If your network router has a static IP address on the Internet, then there is no need to set up a DynDNS service.

### 46.2.1 DynDNS account set-up

Select a DynDNS provider and set up an account. This is done via the DynDNS provider's website.

In general, the following data have to be entered:

- Username
- Password
- E-mail address for confirming the account
- Host name

The host name determines the URL you use to access your PoolManager®. It generally consists of two sections:

1. A freely selectable name, such as *myPoolManager* (the name selected has to be available still)
2. A fixed extension issued by the DynDNS provider, such as *dyndns.org*, *dtdns.net*, *no-ip.com*,... Some providers have various extensions available.

An example of a complete URL for remote access would then be:

*http://myPoolManager.dtdns.net*

DynDNS providers with free services include, for example, *dtdns.net* or *no-ip.com*. For a detailed description on setting up a DynDNS account, please refer to the documentation from the respective provider.

### 46.2.2 DynDNS configuration on a network router

Now you'll have to activate the network router's DynDNS function. This ensures that the router regularly transmits its current IP address to the DynDNS service.

Most modern network routers support the DynDNS function. Should your router not support this function, then we recommend replacing the router.

The DynDNS function is generally configured by entering information about your DynDNS account:

- Username
- Password
- Host name

The exact configuration procedure is heavily dependent upon the router used. Generally, the router has either a Web interface for configuration or a special configuration program.

You'll need the access data (username and password) for accessing router configuration.

For a detailed description, please refer to the documentation for the router being used.

### 46.2.3 Port forwarding on the network router

For remote access to PoolManager®, you'll still need to set up port forwarding on the network router. Port forwarding ensures that the router forwards the respective queries from the Internet to PoolManager®.

Remote access to PoolManager® is realised via the standard HTTP port 80. The port accesses the data recipient, which in this case is PoolManager® web server.

Therefore, port forwarding must be set up as follows:

- Port 80 forwarded to PoolManager® IP address on the local network.
- If applicable, port 80 should be entered as the destination port.

Nearly all modern network routers offer the capacity to set up port forwarding.

For a detailed description, please refer to the documentation for the router being used.

## 46.3 Prerequisites and potential problems

### Requirements for the web browser used

- Support for the current HTML5 standard
- JavaScript activated (it usually is)

### Requirements for the network router

- Port forwarding
- DynDNS function (Only when using a dynamic IP address)
- External access to port 80 may not be blocked
- The router must be configured such that it is permanently connected to the Internet. If it is not connected, then remote access will not be possible.

### Requirements for the Internet Service Provider

- Contract terms and conditions may not prohibit operation of a web server
- You need a public IP address, i.e., your network router's IP address must be visible on the Internet. For some wireless contracts (e.g., LTE without telephony), you are not issued a public IP address. Operating a web server is not possible with that type of contract. A public IP address is generally a dynamic IP address that can change at any time. Unchangeable IP addresses are designated as static or fixed.
- The Internet service provider has to permit access to port 80



### TIP

#### Alternative port 55555

Some Internet service providers block access to the standard HTTP port 80. In that case, port 55555 can be used, which PoolManager® offers as an alternative.

Port forwarding on the router has to be set up accordingly for port 55555.

In the browser, you simply need to add the port to the IP address or URL. The port is separated with a colon, such as

*http://myPoolManager.dtdns.net:55555* or

*http://192.168.1.99:55555*

## 46.4 Multiple PoolManagers® on one network

If there are multiple PoolManagers® running on one network, then each device will be given its own IP address. Remote access from the local network is realised via the corresponding IP address.

For remote access from the Internet, however, direct access of the various IP addresses is not possible.

Instead, external access can be realised various ports, which the router forwards to the individual devices' IP addresses.

**Example:**

**PoolManager® 1**

- IP address 192.168.1.88
- External access via port 80 (standard port), for example: **http://myPoolManager.dtdns.net** (standard port 80 does not have to be indicated in the URL)
- Port-forwarding on the router:  
Port 80 → 192.168.1.88:80

**PoolManager® 2**

- IP address 192.168.1.99
- External access via Port 81, for example: **http://myPoolManager.dtdns.net:81**
- Port-forwarding on the router:  
Port 81 → 192.168.1.99:80

**47 Security for remote access**

In order to guarantee maximum security, remote access is equipped with comprehensive security mechanisms:

- Data transmission in remote access is encrypted (SSL encryption)
- Login with username and password is required
- Supplemental access code necessary in order to modify parameter settings
- The default setting is for remote access to be deactivated
- User rights for remote access can be configured individually
- It is possible to assign different rights for Internet access and for access from the local network

When security requirements are particularly high, established IT concepts can be applied, such as VPN (virtual private network). Consult an IT specialist as needed.



**HAZARD!**

**Unauthorised access**

Despite the highest security standards, there is fundamentally a residual risk for potential unauthorised access when releasing remote access. Unauthorised access can lead to dangerous configurations.

**Potential consequence: Death or the gravest degree of injury, heavy material damage.**

- Do not use trivial usernames or passwords
- Keep usernames and especially passwords strictly confidentially
- Restrict user rights for remote access according to your individual security needs in a sensible manner.
- Only release remote access for the user level actually needed.
- Where possible, use remote access on the local network only and secure it against unauthorised access via the standard measures.
- Where possible, use additional security standards for Internet remote access, e.g., VPN (virtual private network)

**48 Hardware description**



**Required user qualification:**

**ELECTRICAL SPECIALIST**

Electrical connections and all further activities described in this chapter may only be performed by ELECTRICAL SPECIALISTS as defined in the Chapter *User Qualification*.



**HAZARD!**

**Electrostatic charges**

When working on an uncovered unit, electrostatic charges can lead to damage to the sensitive electronic components on PoolManager®.

**Potential consequence: Defective or erroneous functions in PoolManager®.**

- Ground whenever possible while working on an uncovered unit.
- Avoid touching electronic components unnecessarily.

**48.1 System printed circuit board**

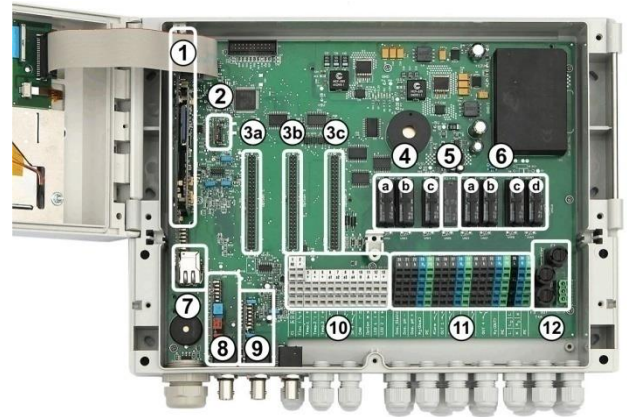

- 1 CPU printed circuit board
- 2 Configuration module (configuration of the controller model, stored device configuration)
- 3 Three expansion plugs for internal add-on modules
- 4 Three dosing relays (socketed)
  - a Disinfection
  - b pH-
  - c pH+
- 5 Alarm relay
- 6 Four relays for add-on functions (socketed)
  - a OUT 1 (normally open contact)
  - b OUT 2 (normally open contact)
  - c OUT 3 (normally open contact)
  - d OUT 4 (changeover contact)
- 7 Network socket Ethernet / RJ45
- 8 pH module (measuring and level monitoring)
- 9 Redox module (measuring and level monitoring)
- 10 Connection terminals of low voltage
- 11 Connection terminals for 230 V~
- 12 Fuses

### 48.2 CPU printed circuit board



- 1 SD memory card (must always be plugged in!)
- 2 CR2032 lithium battery (Buffering for real-time clock)
- 3 USB socket for connecting USB memory sticks

### 48.3 Connection terminals with spring contacts

#### 48.3.1 Technical information

All connection terminals have spring contacts.

Connection terminals are designed for the following conductor cross-sections:

Cable type	Conductor cross-section [mm <sup>2</sup> ]	
	min.	max.
fixed	0.2	2.5
Flexible (no wire end ferrule)	0.2	1.5
Flexible (with wire end ferrule)	0.25	1.5

#### 48.3.1.1 Connect cable



**Required user qualification:**  
**ELECTRICAL SPECIALIST**

Electrical connections may only be performed by an ELECTRICAL SPECIALIST as defined in the chapter *User qualification*.

Spring contacts can be opened with a simple screwdriver in order to connect a cable:

1. Insert a matching screwdriver into the aperture above the terminal as far as possible.
2. Gently pull up on the screwdriver's handle. This lever effect pushes the screwdriver's tip down, thereby opening the spring contact.
3. Once the spring contact is open, insert the cable into the terminal.
4. Pull out the screwdriver.
5. Check that the cable is sitting securely by pulling on it lightly.



#### IMPORTANT NOTICE!

##### Force application on connection terminals

To avoid damage, do not apply any excessive force on the terminal using the screwdriver.

### 48.4 Electrical connections

#### 48.4.1 External connections

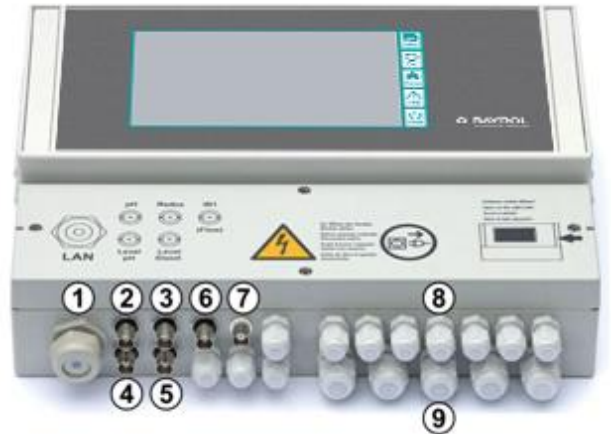

- 1 Cable aperture for network cable
- 2 pH electrode
- 3 Redox (mV) electrode
- 4 Level monitoring pH (suction lance)
- 5 Level monitoring redox (mV) / Cl (suction lance)
- 6 Input IN 1 or flow monitor
- 7 BNC connection for free chlorine measurement (Analyt and PoolManager® PRO)

#### 48.4.1.1 Cable fittings

- 8 11 small cable fittings (for cable diameters 3 mm - 6.5 mm)
- 9 5 large cable fittings (for cable diameters 5 mm - 10 mm)

All cables are inserted into the terminal box via cable fittings. Proceed as follows:

1. Loosen the nut on the cable fitting such that it is barely on the thread. You can also take it off completely.
2. Remove the seal plug.
3. Insert the cable through the nut and cable fitting and into the terminal box.
4. Connect the cable.
5. Tighten the nut (but not forcefully) in order to ensure a reliable seal.

48.4.2 Connection terminals

1	2												
RE	+												
WE	⏏	3	4	5	6	7	8	9	10	11	12	13	
CE	-	+	+	+	a1	a2	a3	a4	H	A	+	+	
					b	b	b	b	L	B	-	-	
RE	+												
WE	⏏												
CE	-												
CI	Flow	Temp.1	Temp.2	Temp.3	IN 1	IN 2	IN 3	IN 4	CAN	Option	LED 1	LED 2	

20	21	22	23	24	25	26	27	28	29	30	31	32	33	34	35	36	37
b	b	b	N <sub>D</sub>	PE	b	b	b	N <sub>F</sub>	PE	b	b	c	N <sub>F</sub>	PE	L	N	PE
a	a	a	N <sub>D</sub>	PE	a	a	a	N <sub>F</sub>	PE	a	a	a	N <sub>F</sub>	PE	L <sub>D</sub>	N <sub>D</sub>	PE
L <sub>D</sub>	L <sub>D</sub>	L <sub>D</sub>	N <sub>D</sub>	PE	L <sub>F</sub>	L <sub>F</sub>	L <sub>F</sub>	N <sub>F</sub>	PE	L <sub>F</sub>	L <sub>F</sub>	L <sub>F</sub>	N <sub>F</sub>	PE	L	N	PE
Dos. Disinf.	Dos. pH -	Dos. pH +	N <sub>D</sub> (Dos.)	PE	Alarm	OUT 1	OUT 2	N <sub>F</sub> (OUT)	PE	OUT 3	OUT 4	N <sub>F</sub> (OUT)	PE	L	L <sub>D</sub>	N	PE

48.4.2.1 Connection terminals of low voltage

No.	Function	Terminal	Notes
1	Potentiostatic chlorine measurement (Analyt and PoolManager PRO only)	RE	Reference electrode (Ag/AgCl)
		WE	Working electrode (gold)
		CE	Counter electrode (platinum)
2	Flow switch (inductive proximity switch "OMRON")	+	Supply voltage
		⏏	Signal output
		-	Ground (GND)
			During flow, the signal output is switched to GND
3	Temperature inputs 1 / 2 / 3	+	Measurement input
4		-	Ground (GND)
5		Temp. 1 / 2    0..50 °C (820..1200Ω) Temp. 3        0..75 °C (820..1400 Ω)	
			Sensor types supported: • PT1000 • KTY83 • KTY16-6 (Parallel resistance 2k Ω required!)
6	Universal switch inputs IN 1 / IN 2 / IN 3 / IN 4	a1/2/3/4	Signal input
7		b	Ground (GND)
8		For connecting <i>potential free</i> external switches or switch contacts.	
9	IN 1 can optionally be used for flow monitoring.		
10	CAN-Bus	H	CAN High
		L	CAN Low
11	Option	A	These terminals are connected with expansion plugs and reserved for future functions.
		B	
12	LED 1 / LED 2	+	5 V with 50 Ω series resistance
13		-	Ground (GND)
			For connecting LEDs for lighting effects (optional)

48.4.2.2 Connection terminals for 230VAC

No.	Function	Terminal	Notes
20	Dosing outputs • Disinfection • pH- • pH+	b	Relay working contact (Dosing output)
21		a	Relay centre contact
22		L <sub>D</sub>	Phase 230 V~ for dosing outputs
	Potential free switch contact between a and b. Wiring bridge from L <sub>D</sub> to a ⇒ 230 V~ on working contact b		
23	Neutral conductor N <sub>D</sub> for dosing outputs	Neutral conductor N <sub>D</sub> is not internally connected with neutral conductors N <sub>F</sub> and N!	
24	Protective earth PE	All PE terminals are connected internally	
25	Alarm relay	b	Relay working contact
26	Relay switch outputs for add-on functions OUT 1 / OUT 2 / OUT 3 / OUT 4	a	Relay centre contact
27		L <sub>F</sub>	Phase 230 V~ for alarm relay and add-on functions
30		Potential free switch contact between a and b. Wiring bridge from L <sub>F</sub> to a ⇒ 230V~ on working contact b	
31			
32	Relay switch output OUT 4 Resting contact	c	Relay resting contact
		a	Relay centre contact
		L <sub>F</sub>	Phase 230 V~ <sup>-1</sup> OUT 4 inactive ⇒ Contact a-c closed
28	Neutral conductor N <sub>F</sub> for alarm relay and add-on functions	Neutral conductor N <sub>F</sub> is internally connected with neutral conductor N, but not with neutral conductor N <sub>D</sub> !	
33			
29	Protective earth PE	All PE terminals are connected internally	
34			
35	Input phase 230V~	L (also L <sub>F</sub> )	PoolManager® supply, alarm relay, and add-on functions (L <sub>F</sub> fused with 4 AT)
		L <sub>D</sub>	Supply dosing outputs
36	Input neutral conductor 230V~	N (also N <sub>F</sub> )	PoolManager® supply, alarm relay, and add-on functions
		N <sub>D</sub>	Supply dosing outputs
37	Protective earth PE	All PE terminals are connected internally	



### 48.5 Power supply 230 V~

PoolManager® has three different branches for 230 V~ supply:

- 230 V~ supply for the PoolManager® unit (L / N / PE, fuse F1 3.15SB)
- 230 V~ supply for dosing outputs (L<sub>F</sub> / N<sub>F</sub> / PE, fuse F2 2SB)
- 230 V~ supply for alarm relay and supplement functions (L<sub>F</sub> / N<sub>F</sub> / PE, fuse F2 2SB)

The following figure schematically shows the connections present on the printed circuit board:

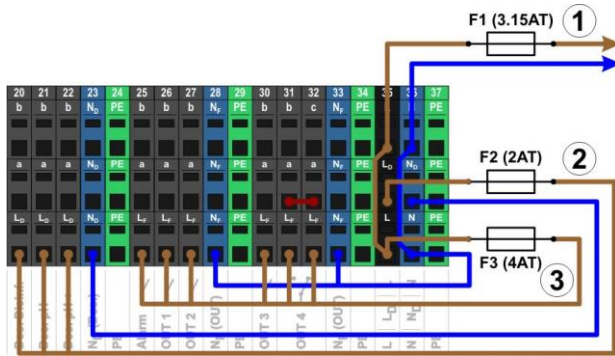

The supply for the PoolManager® unit as well as for the alarm relay and the add-on functions share a mutual power input (L/N). Phase L for PoolManager® is run from the input over via fuse F1. Phase L<sub>F</sub> for the alarm relay and the add-on functions is run from the input via fuse F3. Neutral conductors N and N<sub>F</sub> are connected to each other internally.

Supply to the dosing outputs is run via a separate power input (L<sub>D</sub> / N<sub>D</sub>). This input is fused via F2 and does not have an internal connection to L / L<sub>F</sub> or N / N<sub>F</sub>.



**HAZARD!**

Gaseous chlorine produced from dosing in standing water if dosing outputs are not locked. If the flow switch is stuck or experiences other types of errors, there is a risk of dosing in standing water. Poisonous chlorine gas can be yielded when sodium hypochlorite and pH-Minus come together.

**Potential consequence: Death or the gravest degree of injury, heavy material damage.**

- Only run power to input L<sub>D</sub> / N<sub>D</sub> for the dosing outputs if circulation is running under voltage (dosing outputs locked via filter pump).
- Connect power input L<sub>D</sub> / N<sub>D</sub> to the timer that controls the filter pump, or use the corresponding outlet on the filter pump.
- If PoolManager® is controlling the filter pump directly, then locking automatically occurs internally.

### 48.6 Standard wiring (Without add-on functions)

The following figure schematically shows a typical PoolManager® connection configuration.

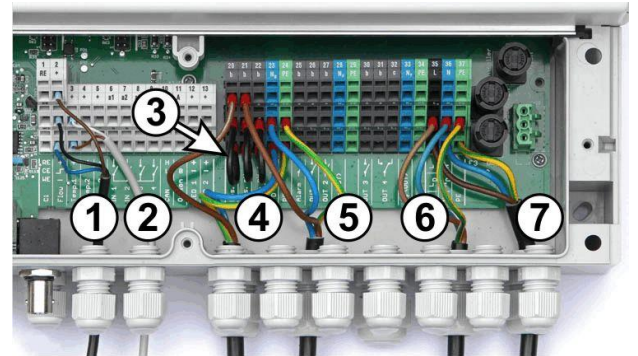

- 1 Flow switch [terminal block 2]
- 2 Temperature sensor [3]
- 3 Wire bridges from L<sub>D</sub> to a for 230 V~ dosing pumps
- 4 Dosing pump disinfection [20]
- 5 Dosing pH-Minus [21]
- 6 230 V~ power supply for dosing pumps [L<sub>D</sub> / N<sub>D</sub> / PE], locks via the filter pump!
- 7 230 V~ power supply for PoolManager®, the alarm relay, and add-on functions [L / N / PE]

#### 48.6.1 Connecting a temperature sensor

Also see the section *Temperature measurement*.

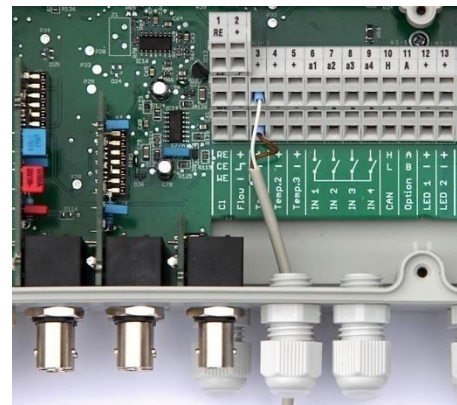

Terminal	Function	Cable colour (standard PT1000 sensor)
[3+] / [4+] / [5+]	Measurement input	White
[3-] / [4-] / [5-]	Ground	Brown



**INFO**

**Extended temperature measurement range for Temp. 3**

Temperature input Temp. 3 is designed for temperatures from 0...75 °C and is therefore particularly well suited for connection with a solar sensor.

Temp. 1 and Temp. 2 are designed for 0...50 °C.

### 48.6.2 Connecting the flow switch

Also see the section *Flow monitoring*.

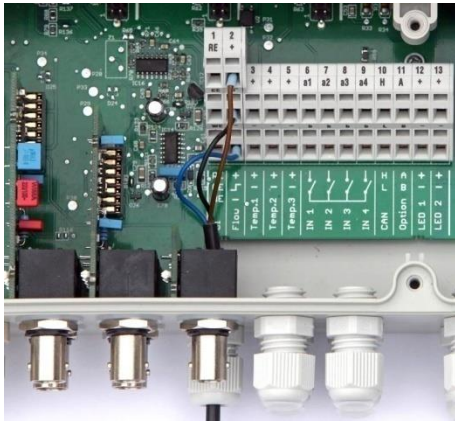

Terminal	Function	Cable colour
[2+]	Supply voltage	Brown
[2-]	Signal output	Signal output
[2-]	Ground (GND)	Blue



**TIP**  
**Connecting a reed contact**

If a simple reed contact or other potential free contact is being used instead of an inductive proximity switch, then it can be connected to the terminals [2-] and [2-].

### 48.6.3 Connection of chlorine measuring cell



**INFO**  
This section applies for the model PoolManager® O2 only.

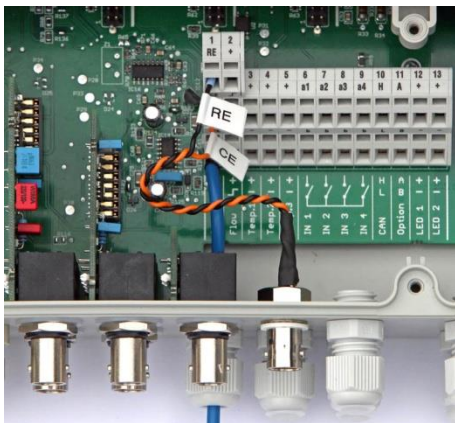

Terminal	Function	Cable colour
[1 RE]	Reference electrode (Ag/AgCl)	Signal output black
[1 CE]	Counter electrode (platinum) Working electrode (gold)	orange
[1 WE]	Working electrode (gold)	Blue



**INFO**  
**Electrode connection**

RE and CE are connected to a BNC socket via adapter cable. The chlorine measuring cell's glass electrode containing the reference electrode (RE) and the counter electrode (platinum round end, CE).

The blue connection cable for the working electrode (WE) is linked directly with the chlorine measuring cell's gold electrode.

## 49 Service measures on the unit

### 49.1 Opening the casing



**IMPORTANT NOTICE!**

**Open on the right**

Never open the casing on the left side, as damage may otherwise occur.

Always open on the right side!

1. Firmly press the hinge on the right side out and to the right.



2. Remove the cover plate and unhook the hinge on the bottom.



3. Swing the casing cover open to the left.



4. To close the casing, reverse this procedure.

### 49.2 Opening the terminal box

The terminal box cover is anchored by four screws. Loosen the four screws and remove the terminal box cover.

When closing, tighten the screws enough that there is a reliable seal.

### 49.3 Fuses

PoolManager® Working electrode (gold) has three lead fuses on the branches of the 230 V~ power supply; also see *Power supply 230 V~*.

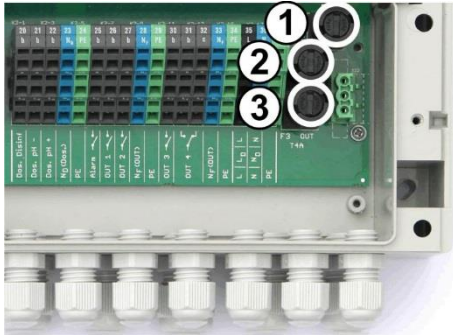

No.	Function	Default value
1 (F1)	PoolManager® supply	3.15 A slow blow
2 (F2)	Supply to dosing outputs	2 A slow blow
3 (F3)	Supply to alarm relay and add-on functions	4 A slow blow

#### 49.3.1 Fuse replacement

- Fuses are housed in a special mount and can be easily replaced.
- Use a matching screwdriver to gently press down on the fuse mount's cover and turn to the left.
- The cover will spring open, and you can replace the fuse.
- To close, set the cover along with the fuse onto the mount. Use the screwdriver to gently press down and carefully turn to the right until the cover clicks into place.

### 49.4 Replacing a relay

All relays (except the alarm relay, which is used little) are individually socketed and can be replaced easily at any time.



- The exact position of the corresponding relay can be found in the section *System printed circuit board* or via the lettering on the printed circuit board.
- First, swing open the plastic retaining bracket to the side.
- Carefully pull out the old relay.
- Carefully press the new relay into the socket.
- Then return the plastic retaining bracket to its original position.

### 49.5 Replacing the buffer battery

PoolManager® has a CR-2032 lithium battery, which is used for buffering the real-time clock while the system is turned off.

This battery has a typical service life of at least 5 to 10 years. PoolManager® reports a battery alarm when battery voltage drops below 2.7 V.



#### HAZARD!

#### Potential malfunctions following battery alarm

Following a battery alarm, it's possible that PoolManager® loses system time when the power is turned off.

#### Potential consequence: PoolManager® malfunctions (e.g., incorrect dosing and switching times)

- If PoolManager® reports a battery alarm, replace the buffer battery within max. 4 weeks.
- It may be necessary to supply PoolManager® with constant 230 V~ power so that the time is not lost.

The battery can be replaced as follows:

1. Turn off PoolManager® power supply.
2. Open the casing.
3. First loosen the flat ribbon cable for better access to the battery. The plug has a lock, which you have to press to the side to unlock.



4. Carefully push a flat screwdriver between the battery mount and the battery.
5. Gently lift the battery out.



6. Press the new battery into the battery mount such that the flat side (+) is on top.
7. Plug the flat ribbon cable back in.
8. Close the front of the casing and turn the power supply back on.



### 49.6 Replacing the configuration module

The configuration module stores PoolManager® device configuration: Maintenance program, optional add-on functions, etc.

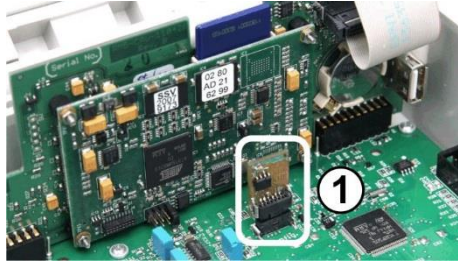

The configuration module is plugged in to a plug socket, making it easy to replace or to plug into another unit.

## 50 Installation of optional supplemental modules

### 50.1 4x power outputs 4...20 mA: PM5-SA4 CONVERTER 4-20MA (Art. no. 127011)

The supplemental module *PM5-SA4 KONVERTER 4-20MA* (Art. no. 127011) provides four outputs 4-20 mA. A second module can be added as needed, such that there is a total of four power outputs available.

The module is simply plugged into one of PoolManager® three module plugs and then configured in the menu.

The power outputs can be used for the following functions:

- Transmitting current measured values (pH, mV, temp.) as power signal 4-20 mA (for videographic recorders, remote displays, building management systems)
- Triggering external systems (e.g., variable filter pumps, salt electrolysis systems)

For more details, please refer to the separate documentation for the *PM5-SA4 CONVERTER 4-20MA* (Art. no. 127011).

## 51 Troubleshooting

The following table shows the typical problems that can arise when operating PoolManager®. Potential causes and remediation measures are indicated for each of the problems.

The table is broken down according to the modules pH, redox (mV), Cl, O2 (Bayrosoft® Light), and temperature.

Type of problem	Potential cause of the problem	Remediation of the problem
<b>pH measurement</b>		
pH control measurement and unit display show different values	Calibration erroneous or was a long time ago	Perform a new calibration
Calibration failure in pH calibration	Erroneous entry of calibration values	Repeat calibration
	Electrode contaminated or defective	Use sensor cleaner or 5-10 % hydrochloric acid to clean the electrode and then rinse with distilled water. If the electrode does not calibrate after this, then it has to be replaced.
	Moisture in cable	Dry or replace cable
	Measurement amplifier defective	Device has to be repaired or replaced
<b>pH control / pH dosing</b>		
The unit shows a dosing output of 0 % although there is a deviation between actual value and setpoint	Dosing is blocked by an alarm (flow, level, or dosing time alarm)	Remediate alarm cause Acknowledge alarm
	Start delay still running	Wait for end of start delay
The dosing pump continues to run despite the unit showing a dosing output of 0 %	Fuse on the dosing pump is burnt	Replace fuse (2 SB)
	Dosing relay defective	Replace the respective relay
	Dosing pump defective	Replace the dosing pump
Dosing pump is running, but there is no pH correction	Container is empty	Replace maintenance product
	Dosing pump has sucked in air and is no longer dosing	Remove air from dosing head
pH value fluctuating around the setpoint	pH control dosing output is too high	Set a higher value for the p-range, which will lower dosing output. Reducing the minimum switch-on time hinders overdosage.
pH value deviates from setpoint over a longer period of time	pH control dosing output is too low	Set a lower value for the p-range, which will increase dosing output. An increase in minimum switch-on time will result in the setpoint be approached more quickly.



Type of problem	Potential cause of the problem	Remediation of the problem
<b>Redox measurement</b>		
Redox potential does not coincide with the control measurement	Calibration erroneous or was a long time ago	Perform a new calibration
Calibration failure in redox calibration	Erroneous entry of calibration values	Repeat calibration
	Electrode contaminated or defective	Use sensor cleaner or 5-10% hydrochloric acid to clean the electrode and then rinse with distilled water. If the electrode does not calibrate after this, then it has to be replaced.
	Moisture in cable	Dry or replace cable
	Measurement amplifier defective	Device has to be repaired or replaced
<b>Redox (mV) control (chlorine or bromine dosing)</b>		
The unit shows a dosing output of 0 % although there is a deviation between actual value and setpoint	Dosing is blocked by an alarm (flow, level, or dosing time alarm)	Remediate alarm cause Acknowledge alarm
	Start delay still running	Wait for end of start delay
The dosing pump continues to run despite the unit showing a dosing output of 0 %	Fuse on the dosing pump is burnt	Replace fuse (2SB)
	Dosing relay defective	Replace the respective relay
	Dosing pump defective	Replace the dosing pump
Dosing pump is running, but there is no redox correction	Container is empty	Replace maintenance product
	Dosing pump has sucked in air and is no longer dosing	Remove air from dosing head
Redox value fluctuating around the setpoint	Redox control dosing output is too high	Set a higher value for the p-range, which will lower dosing output. Reducing the minimum switch-on time hinders overdosing.
Redox potential deviates from setpoint over a longer period of time	Redox control dosing output is too low	Set a lower value for the p-range, which will increase dosing output. An increase in minimum switch-on time will result in the setpoint be approached more quickly.
Type of problem	Potential cause of the problem	Remediation of the problem

Type of problem	Potential cause of the problem	Remediation of the problem
<b>Automatic dosage O2 (Bayrosoff® Light)</b>		
The unit does not trigger dosing at the expected point in time	Dosing is blocked by an alarm (flow or level alarm)	Remediate alarm cause Acknowledge alarm
	Date and time are not correctly configured on the measuring and control unit	Configure date and time on the customer level
Dosing output is higher than the programmed dosing output	The actual dosing output increases due to temperature compensation	-
The dosing pump is not running despite the unit showing dosing output	Fuse on the dosing pump is burnt	Replace fuse (2 SB)
	Dosing relay defective	Replace the respective relay
	Dosing pump defective	Replace the dosing pump
The dosing pump is running, but no maintenance product is reaching the water	Container is empty	Replace maintenance product
	Dosing pump has sucked in air and is no longer dosing	Remove air from dosing head
<b>Temperature measurement</b>		
Temperature display erroneous	Temperature sensor defective	Replace temperature sensor.
	Moisture in cable	Dry or replace cable
	Incorrect sensor type configured (PT1000 / KTY83)	Correct setting in the "temperature" menu (in service menu only)

## 52 Technical data

<b>Measurement dimensions / ranges</b>
<ul style="list-style-type: none"> <li>• pH 0 – 10 (temperature compensated)</li> <li>• Redox 0 – 1,000 mV</li> <li>• Free chlorine 0.01 – 10 ppm / mg/l</li> <li>• Temperature 2x 0 – 50 °C, 1x 0 – 75 °C</li> </ul>
<b>Measurement amplifier tolerances</b>
pH, chlorine, and redox: max. +/- 0.5 % from measurement range terminal value Temperature: max. +/- 0.5 °C
<b>Measuring inputs</b>
pH and redox via BNC, chlorine and temperature via terminal
<b>Control</b>
Proportional control with interval portions (minimum dosing output) Bi-directional control for pH, mono-directional control for redox and chlorine
<b>Dosing outputs</b>
<ul style="list-style-type: none"> <li>• 3 relay switch outputs</li> <li>• Potential free or 230 V~ (max. 2 A)</li> <li>• Pulse widths or pulse frequency triggering</li> </ul>
<b>Alarm relay</b>
Potential free or 230 V~ (max. 4 A)
<b>Inputs / outputs for add-on functions</b>
<ul style="list-style-type: none"> <li>• 4 universal switch inputs (potential free)</li> <li>• 4 universal relay switch outputs, potential free or 230 V~ (max. 4 A)</li> <li>• Unused dosing outputs</li> </ul>
<b>Monitoring functions</b>
<ul style="list-style-type: none"> <li>• Measuring water circuit flow</li> <li>• Pressure switch (optional)</li> <li>• Level pH</li> <li>• Level disinfection</li> </ul>
<b>Expansions</b>
3 plugs for add-on modules
<b>Power outputs 4-20 mA</b>
Plug-in module PM5-SA4 CONVERTER 4-20MA (Art. no. 127011), four outputs 4-20 mA (optional). 1 or 2 modules can be plugged in.
<b>Interfaces</b>
LAN (RJ45) 100 Mbit/s (CAT5 cable minimum) USB, CAN, SD card slot
<b>Communication</b>
Embedded web server and web-based graphical user interface
<b>Electrical connection</b>
100 – 240 V~, 50/60 Hz
<b>Temperature ranges</b>
Operating temperature 0 °C – 50 °C Storage temperature -20 °C – 70 °C
<b>Controller rating</b>
IP 65
<b>Dimensions</b>
715 x 495 x 125 mm (WxHxL)

## EC Declaration of Conformity

We,

**BAYROL Deutschland GmbH  
Robert-Koch-Str. 4  
82152 Planegg/Steinkirchen  
Germany**

, hereby declare that the models of the product named in the following that we bring into circulation meet the requirements of the indicated EC directive.

This declaration will lose its validity in the event of uncoordinated modifications to the product.

Product designation:	<b>Measurement, control, and dosing system PoolManager® / Analyt (5th generation, starting 2012)</b>
Product model:	<b>PoolManager® Cl (Chlorine), PoolManager® Br (Bromine), PoolManager® O2 (Oxygen), PoolManager® PRO, Analyt 2, Analyt 3, Analyt 3 Hotel</b>
Series no.:	<b>See type plate</b>
EC directives:	<b>EC - Low Voltage Directive (2014/35/EU) EC - EMC Directive (2014/30/EU)</b>
Harmonizing standards used:	<b>EN61000-3-2 EN61000-3-3 EN61000-4-2 EN61000-4-3 EN61000-4-3 EN61000-4-4 EN61000-4-5 EN61000-4-6 EN61000-4-8 EN61000-4-11</b>
Date, manufacturer signature:	<b>30.03.2023,</b> 
Signer's information:	<b>Lars Birckenstaedt, Managing Director BAYROL Group</b>

54 UKCA Declaration of Conformity

# UK CA Declaration of Conformity

We,

**BAYROL Deutschland GmbH  
Robert-Koch-Str. 4  
82152 Planegg/Steinkirchen  
Germany**

hereby declare that the models of the product named in the following that we bring into circulation meet the requirements of the listed UKCA regulations.

Product designation: **Measurement, control, and dosing system  
PoolManager® / Analyt (5th generation, starting 2012)**

Product model: **PoolManager® CI (Chlorine), PoolManager® Br (Bromine),  
PoolManager® O2 (Oxygen), PoolManager® PRO,  
Analyt 2, Analyt 3, Analyt 3 Hotel**

Series no.: **See type plate**

UKCA directives: **Electrical Equipment (Safety) Regulations 2016  
(UK SI 2016/1101)  
Electromagnetic Compatibility Regulations 2016  
(UK SI 2016/1091)**

Harmonized standards used: **EN61000-3-2  
EN61000-3-3  
EN61000-4-2  
EN61000-4-3  
EN61000-4-4  
EN61000-4-5  
EN61000-4-6  
EN61000-4-8  
EN61000-4-11**

Date, manufacturer signature: **01.12.2022,** 

Signer's information: **Lars Birkenstaedt  
Managing Director BAYROL Group**